

IT & Data Center

Rack & Enclosure Systems

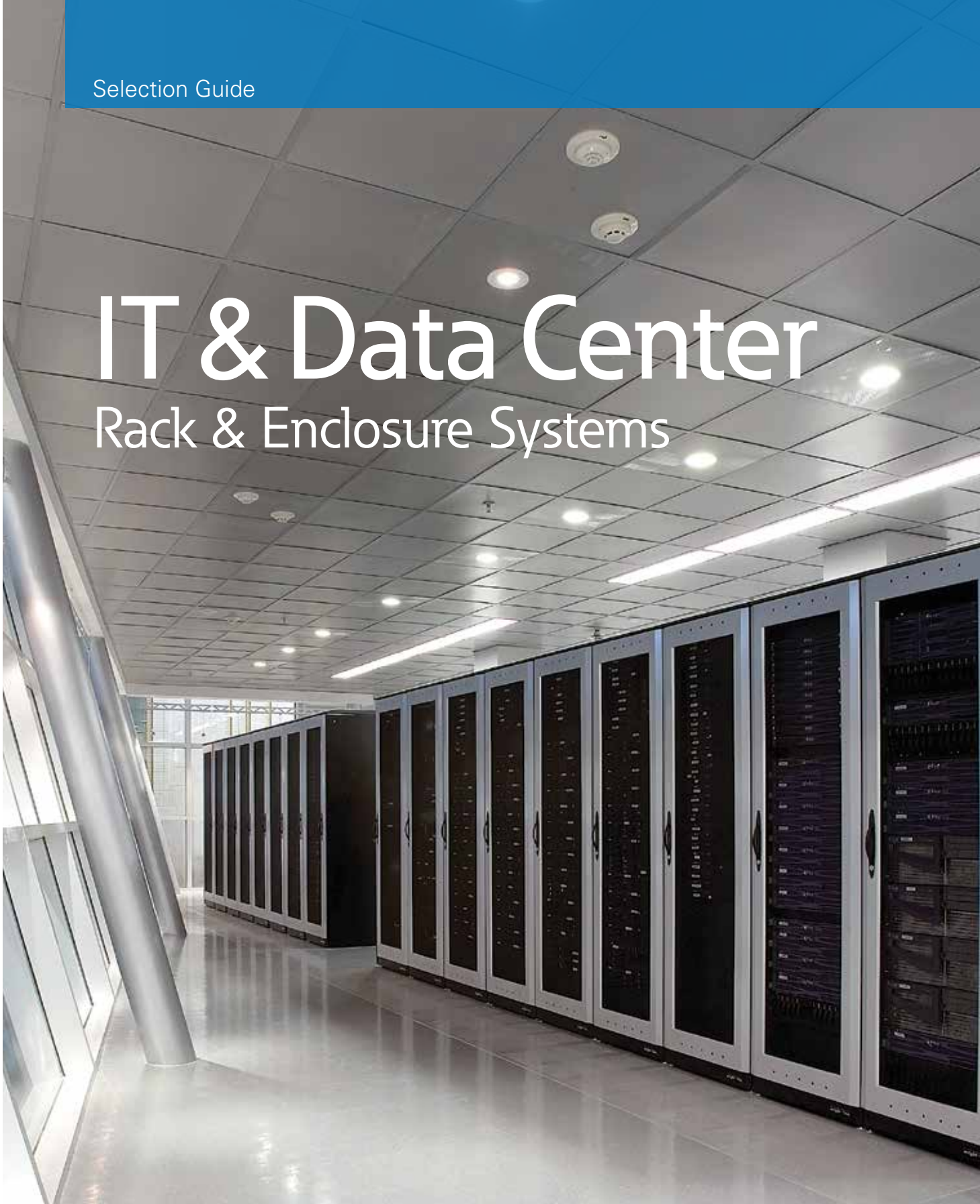

Powering Business Worldwide



Energizing a world that demands more.

Discover today's Eaton.

Powering business worldwide

As a global power management company, we help customers worldwide manage the power needed for buildings, aircraft, trucks, cars, machinery and businesses.

Eaton's innovative technologies help customers manage electrical, hydraulic and mechanical power more reliably, efficiently, safely and sustainably.



EATON

Powering Business Worldwide

Table of Contents

RE Series Rack

| | |
|--------------------------------------|---|
| Small Business Application Solutions | 5 |
|--------------------------------------|---|

REC Series Rack

| | |
|----------------------------------|---|
| Enterprise Data Center Solutions | 8 |
|----------------------------------|---|

Accessories and Enhancements

| | |
|--|----|
| In-Rack Horizontal Cable Management | 11 |
| In-Rack Vertical Cable Management | 12 |
| 9U Active Equipment Cable Manager | 14 |
| 19-inch Cable Strain Relief Bars | 14 |
| 19-inch Cable Entry & Support Panel | 14 |
| Cable Pass Through 19-inch Blanking Panels | 15 |
| 19-inch Horizontal Ring Managers | 15 |
| High Density 19-inch Horizontal Managers | 15 |
| RE / REC Series Adjustable Depth Cable Troughs | 16 |
| RE Series Side Support Rails | 16 |
| Rack Vertical Cable Trays | 17 |
| Rack Vertical Cable Baskets | 17 |
| Rack Front Vertical Cable Channels | 18 |
| Rack Vertical Cable Manager Fingers | 18 |
| Rack Vertical High Density Cable Channels | 19 |
| Twist & Lock Cable Arms | 19 |
| 1U / 2U Cable Ring Kits | 19 |
| Plastic Cable Rings | 20 |
| Velcro® Tie Wraps | 20 |
| Velcro® Buckle Straps | 20 |
| Rack Shelving | 21 |
| Cantilever Shelves | 22 |
| Standard Duty Fixed Adjustable Shelves | 22 |
| Heavy Duty Fixed Shelves | 22 |
| Standard Duty Sliding Shelves | 23 |
| Heavy Duty Sliding Shelves | 23 |
| External Rack Upgrades | 24 |
| RE & REC Top Panels | 25 |
| RE & REC Side Panels | 25 |
| RE & REC Rack Door Locking Upgrade Kits | 26 |

| | |
|--|----|
| Castor Kits | 26 |
| RE & REC Plinth Kits | 26 |
| RE & REC Rack Bolt Together / Baying Kit | 27 |
| Unit Height Labels | 27 |
| ePDU Mounting Kits | 28 |
| RE & REC Series Rack Earth Kit | 28 |
| Universal Rack Earth Bar Kits | 28 |
| Rack Thermal Management | 29 |
| Temperature Strips | 30 |
| Floor Grommets | 30 |
| In Rack Air Management / Blanking Options | 31 |
| Clip-in toolless 19-inch Blanking Panels | 32 |
| PlenaFill® Tear Off 19-inch Blanking Panels | 32 |
| Adjustable Plain Steel 19-inch Blanking Panels | 32 |
| Cable Pass Through 19-inch Blanking Panels | 33 |
| 600mm Wide Rack Air Management Baffles | 33 |
| 800mm Wide Rack Air Management Baffles | 33 |
| Aisle Containment System | 34 |

RE 2-Post Rack Series

| | |
|--|----|
| 2-Post Rack | 36 |
| High Density Vertical Cable Managers | 39 |
| Vertical Cable Basket Kits | 39 |
| High Density 19-inch Horizontal Managers | 40 |
| Universal Rack 19" Earth Bar Kit | 40 |
| Adjustable Cable Spool | 40 |

Rack Configuration

| | |
|-------------|----|
| Handy Hints | 42 |
|-------------|----|

Intelligent Infrastructure for data centers

| | |
|--|----|
| Intelligent infrastructure for IT rooms and data centres | 47 |
| Power protection | 48 |
| Power distribution | 49 |
| Power management | 51 |
| Data center infrastructure monitoring | 51 |



Small, hyper scale or in between, we bring innovation to your data center

Every day the world becomes increasingly reliant on big data. Whether it's connecting regional data centers, supporting vast transactional networks, or providing services to multiple clients, you can benefit from a partner who understands the demands and nuances of your specific IT environment. Regardless of the size of the environment, Eaton delivers the thought leadership and innovation to create IT systems with exceptional reliability and agility that are tailored to your unique needs.



Small Business

IT must provide application availability and support cloud-based architecture, virtualization, consolidation and emerging technologies. Eaton has a variety of products and services to help you keep your IT systems running efficiently without interruption.

RE 2-Post Rack RE Series Rack REC Series Rack



Medium / Large Enterprise

With zero tolerance for risk, IT managers demand reliability and assurance of redundant systems. Data centers must continuously stay in step with the latest technologies and aligned with business strategies. Regardless of your data center's lifecycle – from design/build, commissioning, operation or expansion/ contraction through decommissioning – you can get the most out of your existing data center with the least risk and cost.

RE 2-Post Rack RE Series Rack REC Series Rack



Multi-tenant / Colocation

Faced with the challenge of having to accommodate different business models and solve for unpredictable power and cooling needs, uninterrupted service is everything. Avoiding downtime is critical. And the ability to scale up or down on demand, and faster time to market is crucial. Flexible, modular solutions with state-of-the-art power reliability, efficiency and control help you meet your tenants' needs and maximize your ROI.

RE 2-Post Rack RE Series Rack REC Series Rack



Hyper scale

In today's environment of big data and cloud computing, exponentially increasing volumes of data and demand for different applications must be accommodated quickly and cost-effectively. Growth can't outpace capacity. High performance computing and higher density architecture call for innovative solutions from an expert partner who can help you deploy them efficiently and reliably.

RE 2-Post Rack RE Series Rack REC Series Rack

Recommended & Fully Compatible Available & Compatible

Eaton RE series IT racks deliver essential protection for critical IT equipment in network closet and small server room applications



Designed for fast and easy set-up, the RE Series is provided with features IT specialists need in an affordable, ready-to-go enclosure including casters, lockable side panels, step-less rail positioning, U-markings and a grounding kit.

A full range of easy-to-use cable management, airflow management and storage accessories are available.

Importantly, the RE series provides the ideal platform for seamless integration of critical infrastructure components such as Eaton's UPS's, rack PDUs, power management software and services.

With this full suite of products, integrators can simply install their preferred IT equipment and software and deliver a fully integrated system to their customer.

Standard racks include:

- Fully assembled sturdy rack frame
- Four infinitely adjustable 19" mounting rails with U-markings
- Top panel with configurable infill plates and additional side knock outs on all 800mm wide models
- Split rear doors on all 800mm wide Active Rack configurations and single door on all other configurations
- Swing handles with key lock
- Lockable sides, no-sides version also available
- Casters and levelling feet
- Grounding kit
- 2 year standard warranty.



A Knock outs on 800mm wide tops allow additional cable access

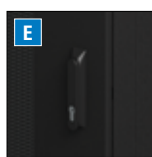

E Secure key locking swing handles on all doors



B User configurable top infill panels



F Infinitely adjustable EIA 310 compliant 19-inch mounting rails

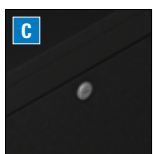

C Key locking removable side panels for added security



G Levelling feet & casters on all enhanced configurations



D Configurable lift off hinges allows field switching of door handing



H Lift off side panel location pegs allows easy side panel removal



Image shows 800mm wide rack configuration

RE Series Rack

Small Business Application Solutions

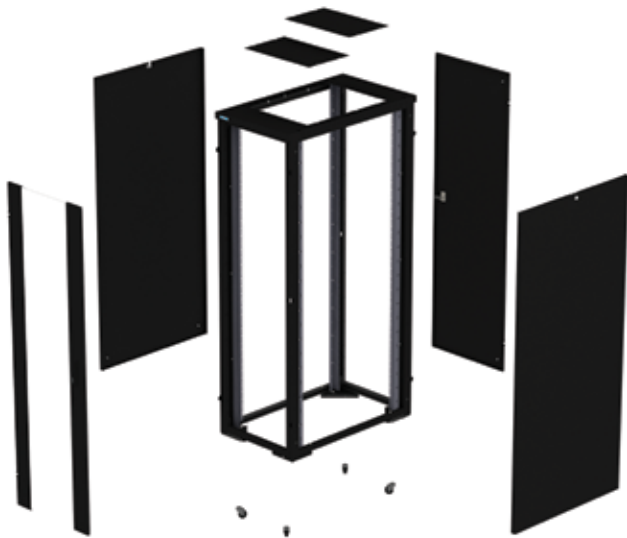

Typical 600mm wide RE Series Basic Rack Configuration

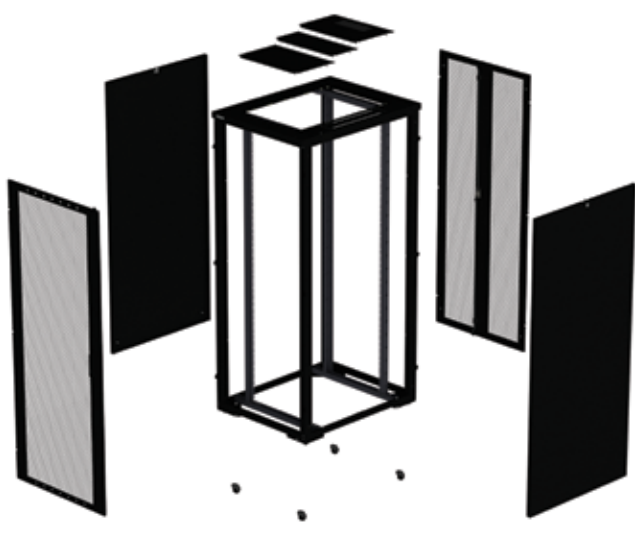

Typical 800mm wide RE Series Active Rack Configuration

| Rack Height | 27U | 27U | 42U | 42U | 27U | 27U | 42U | 42U | 42U | 42U |
|---|--|---------|-----------------------------------|---------|----------|----------|---------|----------|---------|----------|
| Width & depth (mm) | 600x800 | 800x800 | 600x800 | 800x800 | 600x1000 | 800x1000 | 600x800 | 600x1000 | 800x800 | 800x1000 |
| Physical | | | | | | | | | | |
| Height (casters fitted) (mm) | 1382 | 1382 | 2048 | 2048 | 1382 | 1382 | 2048 | 2048 | 2048 | 2048 |
| Width (mm) | 600 | 800 | 600 | 800 | 600 | 800 | 600 | 600 | 800 | 800 |
| Depth (mm) | 840 | 840 | 840 | 840 | 1040 | 1040 | 840 | 1040 | 840 | 1040 |
| Load capacity (static) (kg) | 800 | 800 | 800 | 800 | 800 | 800 | 800 | 800 | 800 | 800 |
| Load capacity (dynamic) (kg) | 200 | 200 | 200 | 200 | 200 | 200 | 200 | 200 | 200 | 200 |
| Weight of assembled rack (with sides) (kg) | 76 | 80 | 102 | 117 | 82 | 84.5 | 102 | 114 | 117 | 128 |
| Front door - glass door model | single | single | single | single | | | | | | |
| Rear door - solid metal (glass door model) | single | single | single | single | | | | | | |
| Front door - perforated (perforated model) | | | | | single | single | single | single | single | single |
| Rear door - perforated (perforated model) | | | | | single | split | split | single | split | split |
| Door material specification | 4mm clear toughened glass to EN 12150 | | 80% free area perforated sections | | | | | | | |
| Door opening angle | 180° angle with non-bayed installations, left-hand hinged, field reversible (140° for bayed racks) | | | | | | | | | |
| Rail mounting depth (maximum) | 482.6mm (19 inch) fully compliant with EIA-310-E. Optional 23 inch width or offset to one side on 800mm models | | | | | | | | | |
| Rail mounting holes | 9.5mm square holes | | | | | | | | | |
| Rail mounting depth (maximum) (mm) | 650 | 650 | 650 | 650 | 850 | 850 | 650 | 850 | 650 | 850 |
| Rail mounting depth—with PDU bracket (mm) | 525 | 525 | 525 | 525 | 725 | 725 | 525 | 725 | 525 | 725 |
| Rail offset | Rails can be offset to either side by 50mm on 800mm wide racks | | | | | | | | | |
| Sides | Removable, lockable side panels—on models with sides | | | | | | | | | |
| Colour | Black, RAL 9005 | | | | | | | | | |
| Heat load suitability - glass door model (kW) | <1.5 | <1.5 | <1.5 | <1.5 | | | | | | |
| Regulatory approvals & standards | EIA-310-E, IEC / EN 60950, IEC / EN 60297, IEC 529 | | | | | | | | | |
| Protection class | IP20—when configured with doors and side panels | | | | | | | | | |
| ePDU maximum length | 27U: 1200mm, 42U: 1865mm. Note: ePDU bracket allows the mounting of 2 rack PDUs side-by-side at the rear of the rack | | | | | | | | | |

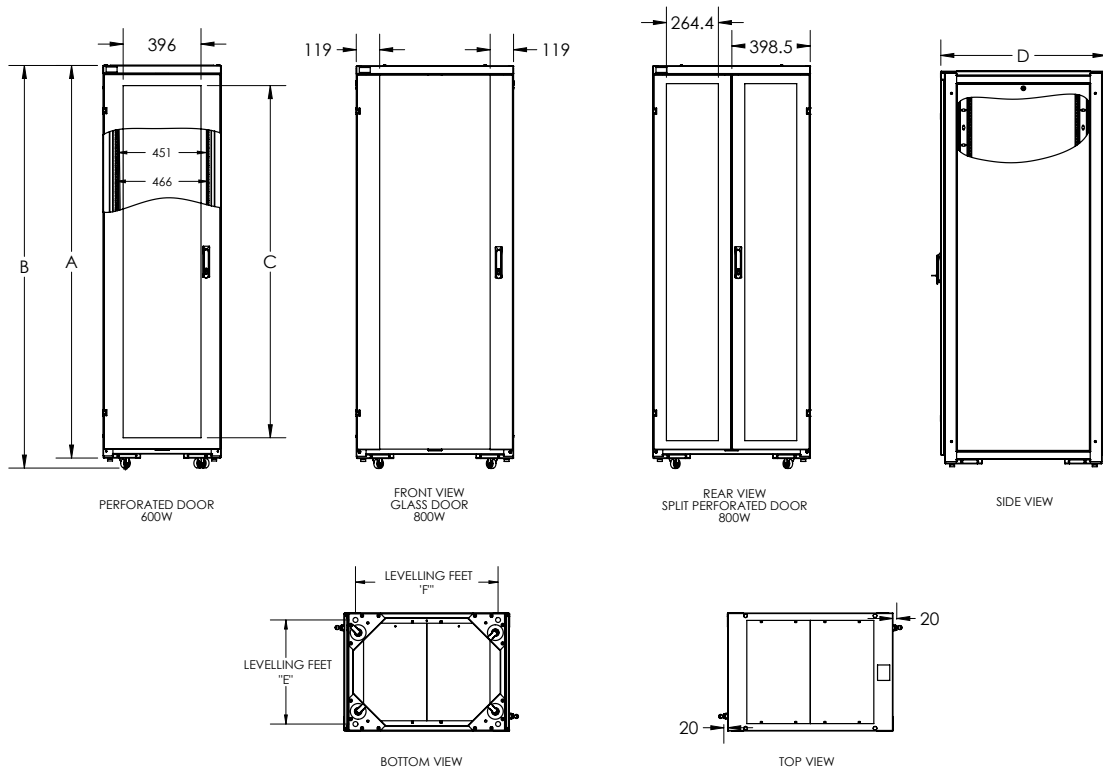

| Models | Height | Width (mm) | Dimensions (mm) | | | | | |
|--------------|--------|------------|-----------------|------|--------|------|-------|-----|
| | | | A | B | C | D | E | F |
| REA27608SPBE | 27U | 600 | 1332 | 1383 | 1034.4 | 840 | 529.5 | 725 |
| REB27608SPBE | 27U | 600 | 1332 | 1383 | n/a | 840 | 529.5 | 725 |
| REA27610SPBE | 27U | 600 | 1332 | 1383 | 1034.4 | 1040 | 529.5 | 925 |
| REA27808SPBE | 27U | 800 | 1332 | 1383 | 1034.4 | 840 | 729.5 | 725 |
| REB27808SPBE | 27U | 800 | 1332 | 1383 | n/a | 840 | 729.5 | 725 |
| REA27810SPBE | 27U | 800 | 1332 | 1383 | 1034.4 | 1040 | 729.5 | 925 |
| REA42608SPBE | 42U | 600 | 1998 | 2049 | 1791 | 840 | 529.5 | 725 |
| REA42608NPBE | 42U | 600 | 1998 | 2049 | 1791 | 840 | 529.5 | 725 |
| REB42608SPBE | 42U | 600 | 1998 | 2049 | n/a | 840 | 529.5 | 725 |
| REA42610SPBE | 42U | 600 | 1998 | 2049 | 1791 | 1040 | 529.5 | 925 |
| REA42610NPBE | 42U | 600 | 1998 | 2049 | 1791 | 1040 | 529.5 | 925 |
| REA42808SPBE | 42U | 800 | 1998 | 2049 | 1791 | 840 | 729.5 | 725 |
| REA42808NPBE | 42U | 800 | 1998 | 2049 | 1791 | 840 | 729.5 | 725 |
| REB42808SPBE | 42U | 800 | 1998 | 2049 | n/a | 840 | 729.5 | 725 |
| REB42808NPBE | 42U | 800 | 1998 | 2049 | n/a | 840 | 729.5 | 725 |
| REA42810SPBE | 42U | 800 | 1998 | 2049 | 1791 | 1040 | 729.5 | 925 |
| REA42810NPBE | 42U | 800 | 1998 | 2049 | 1791 | 1040 | 729.5 | 925 |

Note: n/a indicates "not applicable" due to glass door model.

Order Codes

| | | | | | | | | |
|------------------------------|--------------|--------------|--------------|--------------|--------------|--------------|--------------|--------------|
| Equipment mounting height | 27U | 27U | 27U | 27U | 42U | 42U | 42U | 42U |
| Width x depth (mm) | 600x 800 | 600x1000 | 800x800 | 800x1000 | 600x800 | 600x1000 | 800x800 | 800x1000 |
| Perforated doors, with sides | REA27608SPBE | REA27610SPBE | REA27808SPBE | REA27810SPBE | REA42608SPBE | REA42610SPBE | REA42808SPBE | REA42810SPBE |
| Perforated doors, no sides | | | | | REA42608NPBE | REA42610NPBE | REA42808NPBE | REA42810NPBE |
| Glass door, with sides | REB27608SPBE | | REB27808SPBE | | REB42608SPBE | | REB42808SPBE | |
| Glass door, no sides | | | | | | | REB42808NPBE | |

Eaton's REC Series IT racks deliver essential storage and protection for critical IT equipment in small to medium data center applications



Designed for fast and easy set-up, the REC Series is provided with features IT specialists need in an affordable, ready-to-go enclosure including casters, lockable side panels, truly step-less rail positioning, U-markings and a grounding kit. A full range of easy-to-use cable management, airflow management and storage accessories are also available.

The REC Series can also easily be assembled into aisle containment configurations with pre-fabricated end-of-row doors and horizontal roofs which are simple, fast and easy to install.

Importantly, the REC series provides the ideal platform for seamless integration of critical infrastructure components such as Eaton's UPS's, rack PDUs, power management software and services. With this full suite of products, integrators can simply install their preferred IT equipment and software and deliver a fully integrated system to their customer.

Standard racks include:

- Fully assembled sturdy rack frame
- Four infinitely adjustable 19" mounting rails with U-markings
- Top panel with configurable infill plates and additional side knock out on all 800mm wide models
- Split rear doors on all 800mm wide Active Rack configurations and single door on all other configurations
- Swing handles with key lock
- Lockable sides, no-sides version also available
- Casters and levelling feet
- Pair of ePDU mounting brackets
- Grounding kit
- 2 year standard warranty.



A Knock outs on 800mm wide tops allow additional cable access

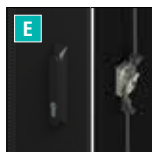

E Secure key locking swing handles on all doors with multi-point locking

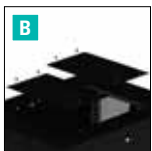

B User configurable top infill panels



F Infinitely adjustable EIA 310 compliant 19-inch mounting rails



C Key locking removable side panels for added security



G Levelling feet & casters on all enhanced configurations

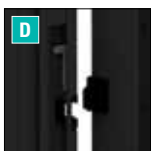

D Configurable lift off hinges allows field switching of door handing



H Lift off side panel location pegs allows easy side panel removal



Image shows 800mm wide rack configuration

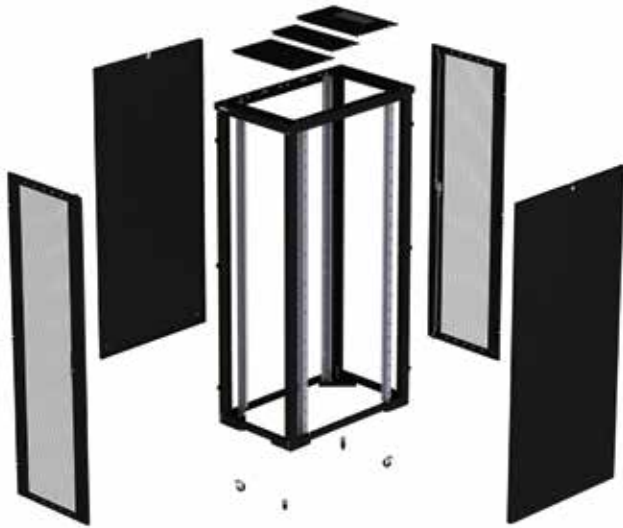

Typical 600mm wide REC Series Basic Rack Configuration

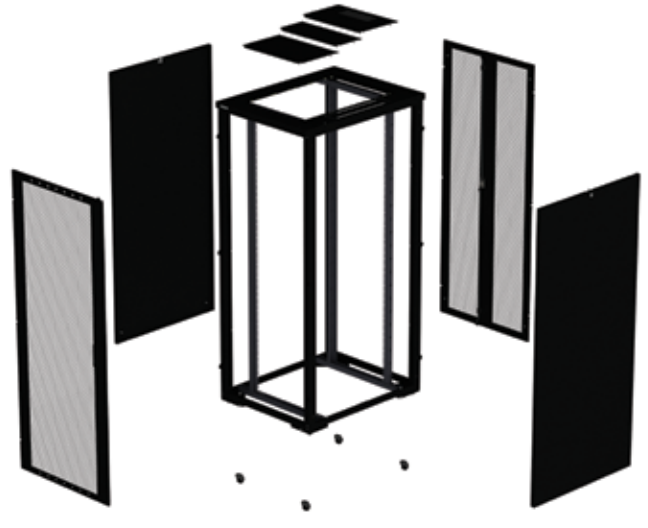

Typical 800mm wide REC Series Active Rack Configuration

| Rack Height | 42U | 42U | 42U | 42U | 47U | 47U | 47U | 47U |
|--|---|-----------------|-----------------|-----------------|-----------------|-----------------|-----------------|-----------------|
| Width & depth (mm) | 600x1000 | 600x1200 | 800x1000 | 800x1200 | 600x1000 | 600x1200 | 800x1000 | 800x1200 |
| Physical | | | | | | | | |
| Height (casters fitted) (mm) | 2048 | 2048 | 2048 | 2048 | 2270 | 2270 | 2270 | 2270 |
| Width (mm) | 600 | 600 | 800 | 800 | 600 | 600 | 800 | 800 |
| Depth (mm) | 1040 | 1240 | 1040 | 1240 | 1040 | 1240 | 1040 | 1240 |
| Load capacity (static) (kg) | 1100 | 1100 | 1100 | 1100 | 1100 | 1100 | 1100 | 1100 |
| Load capacity (dynamic) (kg) | 200 | 200 | 200 | 200 | 200 | 200 | 200 | 200 |
| Weight of assembled rack (with sides) (kg) | 114 | 116 | 128 | 132 | 116 | 127 | 132 | 143 |
| Front door - perforated (perforated model) | single | single | single | single | single | single | single | single |
| Rear door - perforated (perforated model) | single | single | split | split | single | single | split | split |
| Door opening angle | 180° angle with non-bayed installations, left-hand hinged, field reversible (140° for bayed racks) | | | | | | | |
| Door perforations | 80% | | | | | | | |
| Rail mounting depth (maximum) | 482.6mm (19 inch) fully compliant with EIA-310-E. Optional 23 inch width or offset to one side on 800mm models | | | | | | | |
| Rail mounting holes | 9.5mm square holes | | | | | | | |
| Rail mounting depth (maximum) (mm) | 850 | 1048 | 850 | 1048 | 850 | 1048 | 850 | 1048 |
| Rail mounting depth—with PDU bracket (mm) | 725 | 925 | 725 | 925 | 725 | 925 | 725 | 925 |
| Rail offset | Rails can be offset to either side by 50mm on 800mm wide racks | | | | | | | |
| Sides | Removable, lockable side panels(2 locks per side on 1200mm deep models) - on models with sides | | | | | | | |
| Colour | Black, RAL 9005 | | | | | | | |
| Regulatory approvals & standards | EIA-310-E, IEC / EN 60950, IEC / EN 60297, IEC 529 | | | | | | | |
| Protection class | IP20—when configured with doors and side panels | | | | | | | |
| ePDU maximum length | 42U: 1865mm 47U: 2085mm. Note: ePDU bracket allows the mounting of 2 rack PDUs side-by-side at the rear of the rack | | | | | | | |

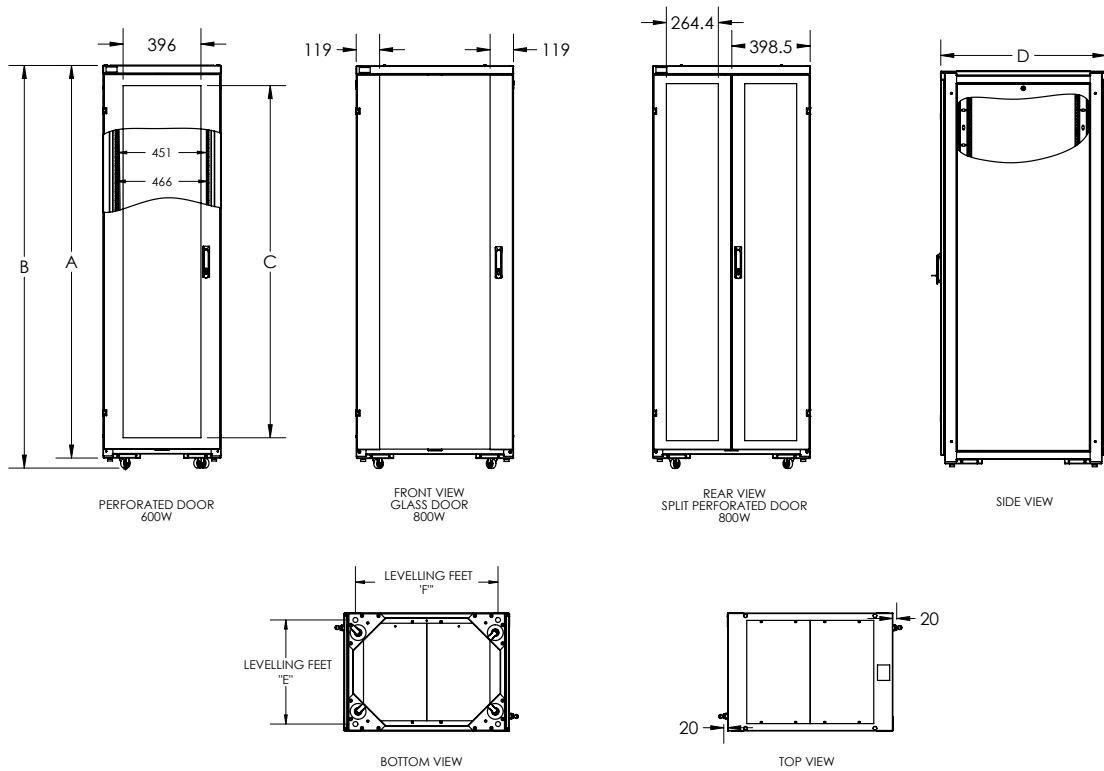

| Models | Height | Width (mm) | Dimensions (mm) | | | | | |
|--------------|--------|------------|-----------------|------|--------|------|-------|------|
| | | | A | B | C | D | E | F |
| RCA42610SPBE | 42U | 600 | 1998 | 2049 | 1816 | 1040 | 529.5 | 925 |
| RCA42610NPBE | 42U | 600 | 1998 | 2049 | 1816 | 1040 | 529.5 | 925 |
| RCA42612SPBE | 42U | 600 | 1998 | 2049 | 1816 | 1240 | 529.5 | 1125 |
| RCA42612NPBE | 42U | 600 | 1998 | 2049 | 1816 | 1240 | 529.5 | 1125 |
| RCA42810SPBE | 42U | 800 | 1998 | 2049 | 1816 | 1040 | 729.5 | 925 |
| RCA42810NPBE | 42U | 800 | 1998 | 2049 | 1816 | 1040 | 729.5 | 925 |
| RCA42812SPBE | 42U | 800 | 1998 | 2049 | 1816 | 1240 | 729.5 | 1125 |
| RCA42812NPBE | 42U | 800 | 1998 | 2049 | 1816 | 1240 | 729.5 | 1125 |
| RCA47610SPBE | 47U | 600 | 2219 | 2270 | 2033.5 | 1040 | 529.5 | 925 |
| RCA47610NPBE | 47U | 600 | 2219 | 2270 | 2033.5 | 1040 | 529.5 | 925 |
| RCA47612SPBE | 47U | 600 | 2219 | 2270 | 2033.5 | 1240 | 529.5 | 1125 |
| RCA47612NPBE | 47U | 600 | 2219 | 2270 | 2033.5 | 1240 | 529.5 | 1125 |
| RCA47810SPBE | 47U | 800 | 2219 | 2270 | 2033.5 | 1040 | 729.5 | 925 |
| RCA47810NPBE | 47U | 800 | 2219 | 2270 | 2033.5 | 1040 | 729.5 | 925 |
| RCA47812SPBE | 47U | 800 | 2219 | 2270 | 2033.5 | 1240 | 729.5 | 1125 |
| RCA47812NPBE | 47U | 800 | 2219 | 2270 | 2033.5 | 1240 | 729.5 | 1125 |

Order Codes

| | | | | | | | | |
|------------------------------|--------------|--------------|--------------|--------------|--------------|--------------|--------------|--------------|
| Equipment mounting height | 42U | 42U | 42U | 42U | 47U | 47U | 47U | 47U |
| Width x depth (mm) | 600x 1000 | 600x1200 | 800x1000 | 800x1200 | 600x1000 | 600x1200 | 800x1000 | 800x1200 |
| Perforated doors, with sides | RCA42610SPBE | RCA42612SPBE | RCA42810SPBE | RCA42812SPBE | RCA47610SPBE | RCA47612SPBE | RCA47810SPBE | RCA47812SPBE |
| Perforated doors, no sides | RCA42610NPBE | RCA42612NPBE | RCA42810NPBE | RCA42812NPBE | RCA47610NPBE | RCA47612NPBE | RCA47810NPBE | RCA47812NPBE |

Eaton offers a range of accessories and retrofit-able upgrades which provide users with the opportunity to optimize the rack and room environment according to installation demands and budget constraints. Many of these accessories can be used on rack platforms from multiple vendors (denoted "Universal").

In-Rack Horizontal Cable Management

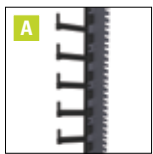

A Active Equipment Cable Manager



B Rack Frame Side Support Rails

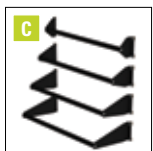

C 19-inch Cable Strain Relief Bars



D 1U Cable Through Support Panel



E Cable Through 19-inch Panels



F Standard 19-inch Cable Managers



G High Density 19-inch Cable Managers



H Adjustable Front To Rear Cable Trough (800mm wide only)



In-Rack Vertical Cable Management

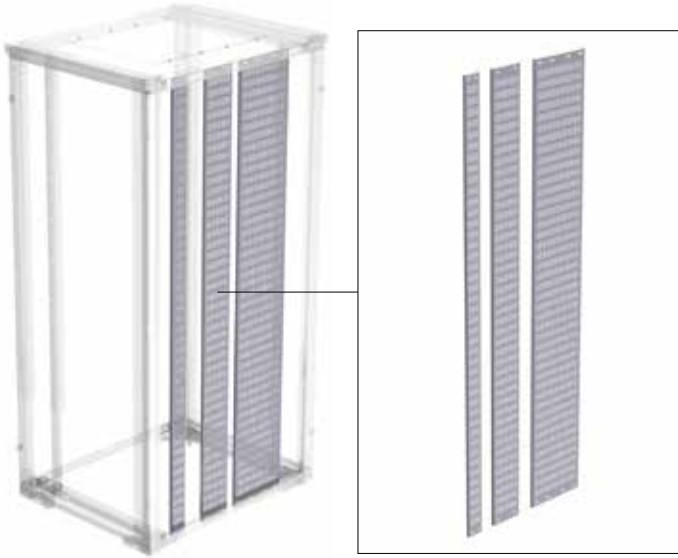

Full height Cable Trays available in a range of widths



Full height Cable Baskets available in a range of widths



Rack Front Vertical Cable Channels with optional Grommets (800mm wide Rack Only)



Can be used with Rack Vertical Cable Manager Fingers

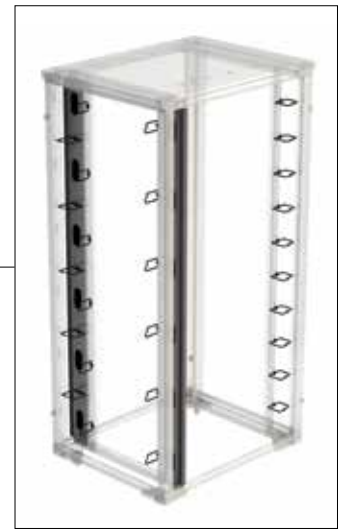

Can Be Used In Conjunctions with a range of Cable Rings

In-Rack Vertical Cable Management

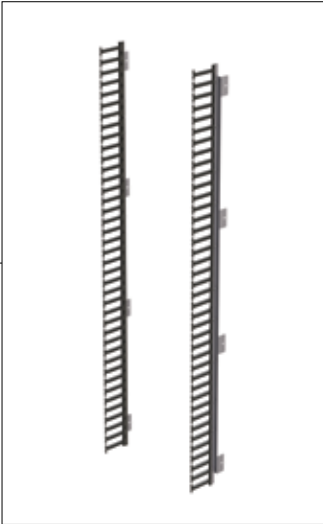

Rack Vertical Cable Manager Fingers available in 27U, 42U & 47U. Suitable For 600mm & 800mm wide Racks

Can be used in conjunction with our range of High Density Horizontal Cable Manager

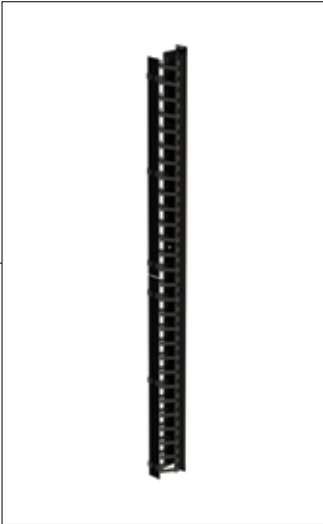

High Density Vertical Cable Managers available in 27U, 42U & 47U. Suitable for 800mm wide racks only

Can be used in conjunction with our range of High Density Horizontal Cable Manager

Accessories and Enhancements

Cable Management Accessories

9U Active Equipment Cable Manager

These 9U cable managers secure to the 19-inch mounting rails. The fingers on the managers are designed to segregate and support the incoming cables, allowing data and power cables to be segregated whilst at the same time promoting bend radius control.



Features / Benefits:

- Best suited to 800mm wide rack platforms
- Universal mount to EIA 310 compliant rails
- Finger spacing aligns to rack Us
- Promotes cable bend radius control
- 115mm Deep.

| Part Code | Description | Compatibility | | | |
|-----------|--|---------------|---------|----------|-----------|
| | | RE 2-Post | RE Rack | REC Rack | Universal |
| ETN-9UECM | 9U Active Equipment Cable Manager (1pcs) | • | • | • | • |

19-inch Cable Strain Relief Bars

These bars mount across the aperture of any EIA 310 compliant 19-inch rails. They allow cables to be adequately supported, avoiding placing strain on the cable terminations and connections.



Features / Benefits:

- Universal mount to EIA 310 compliant rails
- Promotes cable bend radius control
- Multiple depths allow for transitioning of cable to different areas
- Finished black.

| Part Code | Description | Compatibility | | | |
|----------------|--|---------------|---------|----------|-----------|
| | | RE 2-Post | RE Rack | REC Rack | Universal |
| ETN-CMRB19022U | 2U Cable Strain Relief Bar 50mm Deep (1pcs) | • | • | • | • |
| ETN-CMRB19042U | 2U Cable Strain Relief Bar 100mm Deep (1pcs) | • | • | • | • |
| ETN-CMRB19062U | 2U Cable Strain Relief Bar 150mm Deep (1pcs) | • | • | • | • |
| ETN-CMRB19082U | 2U Cable Strain Relief Bar 200mm Deep (1pcs) | • | • | • | • |

19-inch Cable Entry & Support Panel

These 1U panels combine cable through and cable support features. The open edge brush entry allows the panels to be retrofitted after cabling. The brush helps seal around the cables promoting air management and system efficiency. The pierced support tray allows cable to be secured and supported, reducing strain on connections.



Features / Benefits:

- Universal mount to EIA 310 compliant rails
- Pierced tray allows cables to be supported and tied
- Promotes cable bend radius control
- Finished black.

| Part Code | Description | Compatibility | | | |
|------------|---------------------------------------|---------------|---------|----------|-----------|
| | | RE 2-Post | RE Rack | REC Rack | Universal |
| ETN-BSP1UB | 1U Cable Entry & Support Panel (1pcs) | • | • | • | • |

Cable Pass Through 19-inch Blanking Panels

Available in 1U and 2U height options, these cable through panels allow cables to be passed through the 19-inch aperture without compromising in-rack air management.



Benefits:

- Universal mount to all square pierced EIA 310 compliant rails
- Cable through feature with brush seal.

| Part Code | Description | Compatibility | | | |
|-----------|--|---------------|---------|----------|-----------|
| | | RE 2-Post | RE Rack | REC Rack | Universal |
| ETN-OBSP1 | Blanking Panel 19" - Brush Cable Entry 1U (1pcs) | • | • | • | • |
| ETN-OBSP2 | Blanking Panel 19" - Brush Cable Entry 2U (1pcs) | • | • | • | • |

19-inch Horizontal Ring Managers

Available in 1U and 2U panel heights, these cable management panels are the industry default to the management of patch cabling. Configured with four rings per panel the 1U version is designed to managed 24 cables and the 2U version 48 cables.



Features / Benefits:

- Universal mount to EIA 310 compliant rails
- Open rings allow easy management of cables
- Cable ring depth: 1U = 70mm 2U = 140mm
- Finished black
- Supplied with cage nuts and screws for rack mounting.

| Part Code | Description | Compatibility | | | |
|-----------|--|---------------|---------|----------|-----------|
| | | RE 2-Post | RE Rack | REC Rack | Universal |
| ETN-JRP1 | 1U Horizontal 19" Basic Cable Manager (1pcs) | • | • | • | • |
| ETN-JRP1 | 2U Horizontal 19" Basic Cable Manager (1pcs) | • | • | • | • |

High Density 19-inch Horizontal Managers

Horizontal cable managers are available in heights of 1U, 2U & 3U. The depth of the unit allows for higher density cabling. Units allow cable transitions across the rack space, front to rear through the 19-inch aperture and above and below the managers to adjacent devices or patch panels.



Features / Benefits:

- Universal mount to EIA 310 compliant rails
- Promotes cable bend radius control
- Clip-on hinged covers hide cable tails
- Unit depth 145mm
- Finished black.

| Part Code | Description | Compatibility | | | |
|--------------|---|---------------|---------|----------|-----------|
| | | RE 2-Post | RE Rack | REC Rack | Universal |
| ETN-HDHCM1UB | 1U High Density Horizontal 19" Cable Manager (1pcs) | • | • | • | • |
| ETN-HDHCM2UB | 2U High Density Horizontal 19" Cable Manager (1pcs) | • | • | • | • |
| ETN-HDHCM3UB | 3U High Density Horizontal 19" Cable Manager (1pcs) | • | • | • | • |

Accessories and Enhancements

Cable Management Accessories

RE / REC Series Adjustable Depth Cable Troughs

These cable troughs are designed to mount into the side of 800mm wide RE / REC Series racks with the 19-inch rails mounted centrally. The troughs mount directly to the 19-inch rails and incorporate adjustment to suit rail mounting centers. The troughs provide the ideal solution for front to rear cable transition in the rack space.



Features / Benefits:

- Designed to mount into the side of 800mm wide racks **only**
- Varying depth options to suit differing 19-inch rail centers
- Supplied with fixings and mounting instructions
- Finished black.

| Part Code | Description | Compatibility | | | |
|-------------|---|---------------|---------|----------|-----------|
| | | RE 2-Post | RE Rack | REC Rack | Universal |
| ETN-2UCT-1B | RE Series Adjustable Cable Trough 408 - 427mm (1pcs) | n/a | • | • | n/a |
| ETN-2UCT-2B | RE Series Adjustable Cable Trough 408 - 608mm (1pcs) | n/a | • | • | n/a |
| ETN-2UCT-3B | RE Series Adjustable Cable Trough 608 - 808mm (1pcs) | n/a | • | • | n/a |
| ETN-2UCT-4B | RE Series Adjustable Cable Trough 808 - 1006mm (1pcs) | n/a | • | • | n/a |

RE Series Side Support Rails

Designed to mount into the side of the RE and REC Series racks, these side support rails can be bolted in position at the bottom, middle and top of each rack side. They are slotted to allow ties to be used to secure services to the side of the racks. The rails are designed so they can be used in conjunction with side panels in both 600mm and 800mm wide rack configurations.



Features / Benefits:

- Supplied with fixings and mounting instructions
- Finish: Pre galvanized zinc.

| Part Code | Description | Compatibility | | | |
|---------------|---|---------------|---------|----------|-----------|
| | | RE 2-Post | RE Rack | REC Rack | Universal |
| ETN-SSK600PG | RE Series Side Support Rail - 600mm D (1pcs) | n/a | • | • | n/a |
| ETN-SSK800PG | RE Series Side Support Rail - 800mm D (1pcs) | n/a | • | • | n/a |
| ETN-SSK1000PG | RE Series Side Support Rail - 1000mm D (1pcs) | n/a | • | • | n/a |
| ETN-SSK1200PG | RE Series Side Support Rail - 1200mm D (1pcs) | n/a | n/a | • | n/a |



Rack Vertical Cable Trays

These vertical cable trays mount into the side of the RE and REC Series rack platforms. They are designed to mount to the front to rear side frame members using slide nuts to allow them to be positioned to suit the application and space constraints.



Features / Benefits:

- Three width options for varying cabling volumes
- Slotted profile allows services to be secured to trays
- Supplied with fixings and mounting instructions
- Finish: Pre galvanized zinc.

| Part Code | Description | Compatibility | | | |
|----------------|--|---------------|---------|----------|-----------|
| | | RE 2-Post | RE Rack | REC Rack | Universal |
| ETN-27CTK075PG | RE Series 27U x 75mm Wide Cable Tray Kit (1pcs) | n/a | • | n/a | n/a |
| ETN-42CTK075PG | RE Series 42U x 75mm Wide Cable Tray Kit (1pcs) | n/a | • | • | n/a |
| ETN-47CTK075PG | RE Series 47U x 75mm Wide Cable Tray Kit (1pcs) | n/a | • | • | n/a |
| ETN-27CTK150PG | RE Series 27U x 150mm Wide Cable Tray Kit (1pcs) | n/a | • | n/a | n/a |
| ETN-42CTK150PG | RE Series 42U x 150mm Wide Cable Tray Kit (1pcs) | n/a | • | • | n/a |
| ETN-47CTK150PG | RE Series 47U x 150mm Wide Cable Tray Kit (1pcs) | n/a | • | • | n/a |
| ETN-27CTK300PG | RE Series 27U x 300mm Wide Cable Tray Kit (1pcs) | n/a | • | n/a | n/a |
| ETN-42CTK300PG | RE Series 42U x 300mm Wide Cable Tray Kit (1pcs) | n/a | • | • | n/a |
| ETN-47CTK300PG | RE Series 47U x 300mm Wide Cable Tray Kit (1pcs) | n/a | • | • | n/a |

Rack Vertical Cable Baskets

Like the vertical cable baskets these mount into the side of the RE and REC Series rack platforms. They are designed to mount to the front to rear side frame members using slide nuts to allow them to be positioned to suit the application and space constraints.



Features / Benefits:

- Two width options for varying cabling volumes
- Ideally designed for 800mm wide rack applications
- Supplied with fixings and mounting instructions
- Finish: Zinc plated.

| Part Code | Description | Compatibility | | | |
|----------------|--|---------------|---------|----------|-----------|
| | | RE 2-Post | RE Rack | REC Rack | Universal |
| ETN-27CBK150ZP | RE Series 27U x 150mm Wide Cable Basket Kit (1pcs) | n/a | • | n/a | n/a |
| ETN-42CBK150ZP | RE Series 42U x 150mm Wide Cable Basket Kit (1pcs) | n/a | • | • | n/a |
| ETN-47CBK150ZP | RE Series 47U x 150mm Wide Cable Basket Kit (1pcs) | n/a | • | • | n/a |
| ETN-27CBK300ZP | RE Series 27U x 300mm Wide Cable Basket Kit (1pcs) | n/a | • | n/a | n/a |
| ETN-42CBK300ZP | RE Series 42U x 300mm Wide Cable Basket Kit (1pcs) | n/a | • | • | n/a |
| ETN-47CBK300ZP | RE Series 47U x 300mm Wide Cable Basket Kit (1pcs) | n/a | • | • | n/a |

Accessories and Enhancements

Cable Management Accessories

Rack Front Vertical Cable Channels

Designed to mount vertically on the outside of the 19-inch rails on 800mm wide RE and REC Series racks. The cable channels provide simple vertical cable management and incorporate the ability to fit cable through grommets (available separately).

Features / Benefits:

- Retrofit-able and easy to install
- Incorporates multiple cable through apertures with sealing grommets option
- Helps to promote optimal air flow through the rack space
- Finished black
- Supplied with fixings and mounting instructions.



| Part Code | Description | Compatibility | | | |
|-------------|---|---------------|---------|----------|-----------|
| | | RE 2-Post | RE Rack | REC Rack | Universal |
| ETN-CCK27UB | RE Series 27U Front Vertical Cable Channel (1pcs) | n/a | • | n/a | n/a |
| ETN-CCK42UB | RE Series 42U Front Vertical Cable Channel (1pcs) | n/a | • | • | n/a |
| ETN-CCK47UB | RE Series 47U Front Vertical Cable Channel (1pcs) | n/a | • | • | n/a |
| ETN-ACCGROM | Oval Grommet - 38mm x 100mm (10pcs) | n/a | • | • | • |

Rack Vertical Cable Manager Fingers

Supplied in pairs, these fingers are designed to mount to the side of the RE and REC Series rack platform 19-inch rails. They will fit to all rack widths but they are ideally suited to 800mm wide rack variants. They can be used in conjunction with the Rack Front Vertical Channels to provide a flexible cable management solution.

Features / Benefits:

- Retrofit-able (needs access to the inside of the mounting rail at mounting points)
- Promotes cable bend radius control
- Requires 19-inch rails to be set back 150mm
- Finished black
- Supplied with fixings and mounting instructions.



| Part Code | Description | Compatibility | | | |
|---------------|---|---------------|---------|----------|-----------|
| | | RE 2-Post | RE Rack | REC Rack | Universal |
| ETN-42URCMFKB | RE Series 42U Vertical Cable Manager Fingers (pair) | n/a | • | • | n/a |
| ETN-47URCMFKB | RE Series 47U Vertical Cable Manager Fingers (pair) | n/a | • | • | n/a |

Rack Vertical High Density Cable Channels

Supplied in single units, these vertical cable managers are designed to be mounted in 800mm wide RE and REC Series racks. Units are supplied complete with dual hinged split covers for ease of operation and improved cable management and incorporate cable through features in the rear of the units.



Features / Benefits:

- Retrofit-able
- Promotes cable bend radius control
- Requires 19-inch rails to be set back 150mm
- Finished black
- Supplied with fixings and mounting instructions.

| Part Code | Description | Compatibility | | | |
|--------------|--|---------------|---------|----------|-----------|
| | | RE 2-Post | RE Rack | REC Rack | Universal |
| ETN-VCMA27UB | RE Series 27U High Density Vertical Cable Channel (1pcs) | n/a | • | • | n/a |
| ETN-VCMA42UB | RE Series 42U High Density Vertical Cable Channel (1pcs) | n/a | • | • | n/a |
| ETN-VCMA47UB | RE Series 47U High Density Vertical Cable Channel (1pcs) | n/a | • | • | n/a |

Twist & Lock Cable Arms

These tool-less cable support arms are designed to be attached to the side of the standard 19-inch mounting rails in the 800mm wide variants of the RE and REC Series rack platforms. The standard arms can be upgraded to add divider rings to help segregate data and power cabling. The enhanced end cap upgrade provides enhanced cable management capabilities.



Features / Benefits:

- Finished light grey.

| Part Code | Description | Compatibility | | | |
|------------|---|---------------|---------|----------|-----------|
| | | RE 2-Post | RE Rack | REC Rack | Universal |
| ETN-TLCMS | Cable Support Arms + Std End Caps (10pcs) | • | • | • | n/a |
| ETN-TLCMR | Cable Support Arms + Divider Rings (10pcs) | • | • | • | n/a |
| ETN-TLCMEE | Cable Support Arm Enhanced End Caps (10pcs) | • | • | • | n/a |

1U / 2U Cable Ring Kits

1U and 2U high metal cable rings provide cable management capabilities in multiple locations. Each hoop can be screw fixed into position using standard M6 screws.



Mounting positions include: Features / Benefits:

- | | |
|---|---|
| <ul style="list-style-type: none"> • Front of 19-inch rails • Side of 19-inch rails • RE and REC 800mm wide Front Vertical Cable Channels • Inside the RE and REC Vertical High Density Cable Channels. | <ul style="list-style-type: none"> • Open rings allow easy management of cables • Cable ring depth: 1U = 85mm 2U = 170mm • Finished black. |
|---|---|

| Part Code | Description | Compatibility | | | |
|----------------|------------------------------|---------------|---------|----------|-----------|
| | | RE 2-Post | RE Rack | REC Rack | Universal |
| ETN-CMDRNR031U | Cable Ring - 1U Metal (4pcs) | • | • | • | • |
| ETN-CMDRNR032U | Cable Ring - 2U Metal (4pcs) | • | • | • | • |

Accessories and Enhancements

Cable Management Accessories

Plastic Cable Rings

Available in two sizes these plastic rings provide cable management capabilities in multiple locations. Each hoop can be screw fixed into position using M6 screws.

Mounting positions include: Features / Benefits:

- | | |
|---|---|
| <ul style="list-style-type: none"> • Front of 19-inch rails • Side of 19-inch rails • RE and REC 800mm wide Front Vertical Cable Channels • Inside the RE and REC Vertical High Density Cable Channels. | <ul style="list-style-type: none"> • Clip locking facility allows easy management of cables with secure closure • ETN-CTS cable hoop external dimensions: approximately 90mm x 55mm x 29mm • ETN-CTL cable hoop external dimensions: approximately 127mm x 70mm x 29mm • Finished light grey. |
|---|---|



| Part Code | Description | Compatibility | | | |
|-----------|-----------------------------------|---------------|---------|----------|-----------|
| | | RE 2-Post | RE Rack | REC Rack | Universal |
| ETN-CTS | Cable Ring - Small Plastic (1pcs) | • | • | • | • |
| ETN-CTL | Cable Ring - Large Plastic (1pcs) | • | • | • | • |

Velcro® Tie Wraps

These Velcro® tie wraps are available in two lengths to suit varying cable volumes. Ideal for safely bundling cables and securing to various structures on or inside a rack, these re-useable ties are ideal for use with cable trays, cable baskets, side support channels, vertical high density cable channels, horizontal cable ring managers, high density horizontal cable managers as well as other applications.



Features / Benefits:

- Can be used in many applications
- Helps avoid damage to cables and promotes tidy cabling structures
- Helps promote rack hygiene and promote efficient thermal operation
- Finished black.

| Part Code | Description | Compatibility | | | |
|-------------|--------------------------------------|---------------|---------|----------|-----------|
| | | RE 2-Post | RE Rack | REC Rack | Universal |
| ETN-BX45V8 | Velcro Tie Wrap 200mm x 13mm (50pcs) | • | • | • | • |
| ETN-BX45V11 | Velcro Tie Wrap 280mm x 13mm (50pcs) | • | • | • | • |

Velcro® Buckle Straps

These Velcro® buckle straps are available in two lengths to suit varying cable volumes. Ideal for safely bundling cables and screw fixing to various structures on or inside a rack these reusable ties are ideal for use with 19-inch mounting rails and other structures with secure screw mounting points.



Features / Benefits:

- Can be used in many applications
- Helps avoid damage to cables and promotes tidy cabling structures
- Helps promote rack hygiene and promote efficient thermal operation
- Finished black.

| Part Code | Description | Compatibility | | | |
|--------------|---|---------------|---------|----------|-----------|
| | | RE 2-Post | RE Rack | REC Rack | Universal |
| ETN-CMVBCKL | Velcro Buckle Straps 230mm x 13mm (10pcs) | • | • | • | • |
| ETN-CMVBKL12 | Velcro Buckle Straps 300mm x 13mm (10pcs) | • | • | • | • |

Rack Shelving



1U, 2U & 3U
19-inch mounted
cantilever



Standard duty &
heavy duty 19-inch
mounted fixed
adjustable shelves



Standard duty
19-inch mounted
sliding shelves -
adjustable
mounting depth



Heavy duty 19-inch
mounted sliding
shelves - adjustable
mounting depth



| Order Code | Description | Load Rating | Min Depth | Max Depth | Rack Depth (mm) / Type | | | | |
|----------------|---|-------------|-----------|-----------|------------------------|-----|-----|------|------|
| | | | | | 2-Post | 600 | 800 | 1000 | 1200 |
| ETN-MS19B | Shelf - 19" Cantilever 1U x 190mm Deep | 35kg | 190 | n/a | • | • | • | • | • |
| ETN-MS40B | Shelf - 19" Cantilever 2U x 400mm Deep | 35kg | 400 | n/a | • | • | • | • | • |
| ETN-MS403B | Shelf - 19" Cantilever 3U x 400mm Deep | 35kg | 400 | n/a | • | • | • | • | • |
| ETN-SDFAS1U45B | Shelf - 19" Std Duty Fixed Adjustable 1U x 450D | 100kg | 450 | 750 | n/a | • | • | • | • |
| ETN-HDFAS1U45B | Shelf - 19" Heavy Duty Fixed Adjustable 1U x 450D | 250kg | 450 | 750 | n/a | • | • | • | • |
| ETN-HDFAS1U65B | Shelf - 19" Heavy Duty Fixed Adjustable 1U x 650D | 250kg | 650 | 950 | n/a | n/a | • | • | • |
| ETN-LDATSV45B | Shelf - 19" Standard Duty Sliding 450D | 50kg | 455 | 749 | n/a | • | • | • | • |
| ETN-LDATSV55B | Shelf - 19" Standard Duty Sliding 550D | 50kg | 555 | 812 | n/a | n/a | • | • | • |
| ETN-LDATSV70B | Shelf - 19" Standard Duty Sliding 700D | 50kg | 705 | 940 | n/a | n/a | • | • | • |
| ETN-QRTSV45B | Shelf - 19" Heavy Duty Sliding 450D | 125kg | 363 | 513 | n/a | • | • | • | • |
| ETN-QRTSV60B | Shelf - 19" Heavy Duty Sliding 600D | 125kg | 513 | 663 | n/a | n/a | • | • | • |
| ETN-QRTSV75B | Shelf - 19" Heavy Duty Sliding 750D | 125kg | 663 | 813 | n/a | n/a | • | • | • |

Cantilever Shelves

These shelves are designed to mount into any EIA 310 compliant 19-inch rack. They can be used to support non rack mounted IT components such as monitors and modems. Perforated mounting surface provides tie down points.



Features / Benefits:

- Universal mount to EIA 310 compliant rails
- Load capacity 35kg evenly distributed (2 point mounting)
- Finished black
- Supplied with fixings and mounting instructions.

| Part Code | Description | Compatibility | | | |
|------------|--|---------------|---------|----------|-----------|
| | | RE 2-Post | RE Rack | REC Rack | Universal |
| ETN-MS19B | Shelf - 19" Cantilever 1U x 190mm Deep | • | • | • | • |
| ETN-MS40B | Shelf - 19" Cantilever 2U x 400mm Deep | • | • | • | • |
| ETN-MS403B | Shelf - 19" Cantilever 3U x 400mm Deep | • | • | • | • |

Standard Duty Fixed Adjustable Shelves

These shelves are designed to mount into any EIA 310 compliant 19-inch rack. They can be used to support non rack mounted IT components such as monitors and modems. Perforated mounting surface provides tie down points.



Features / Benefits:

- Universal mount to EIA 310 compliant rails
- Load capacity 100kg evenly distributed (4 point mounting)
- Usable depth 450mm - Mounting rails centers 450 -750mm
- Finished black
- Supplied with fixings and mounting instructions.

| Part Code | Description | Compatibility | | | |
|----------------|---|---------------|---------|----------|-----------|
| | | RE 2-Post | RE Rack | REC Rack | Universal |
| ETN-SDFAS1U45B | Shelf - 19" Std Duty Fixed Adjustable 1U x 450D | n/a | • | • | • |

Heavy Duty Fixed Shelves

These shelves are designed to mount into any EIA 310 compliant 19-inch rack. They can be used to support non rack mounted IT components such as monitors and modems. Perforated mounting surface provides tie down points.



Features / Benefits:

- Universal mount to EIA 310 compliant rails
- Load capacity 250kg evenly distributed (4 point mounting)
- Usable depth 450mm - Mounting rails centers 450 -750mm
- Usable depth 650mm - Mounting rails centers 650 - 950mm
- Finished black
- Supplied with fixings and mounting instructions.

| Part Code | Description | Compatibility | | | |
|----------------|---|---------------|---------|----------|-----------|
| | | RE 2-Post | RE Rack | REC Rack | Universal |
| ETN-HDFAS1U45B | Shelf - 19" Heavy Duty Fixed Adjustable 1U x 450D | n/a | • | • | • |
| ETN-HDFAS1U65B | Shelf - 19" Heavy Duty Fixed Adjustable 1U x 650D | n/a | • | • | • |

Standard Duty Sliding Shelves

These shelves are designed to mount into any EIA 310 compliant 19-inch rack. They can be used to support non rack mounted IT components such as monitors and modems. Perforated mounting surface provides tie down points.



Features / Benefits:

- Universal mount to EIA 310 compliant rails
- Load capacity 50kg evenly distributed (4 point mounting)
- Finished black
- Supplied with fixings and mounting instructions.

| Part Code | Description | Compatibility | | | |
|---------------|---|---------------|---------|----------|-----------|
| | | RE 2-Post | RE Rack | REC Rack | Universal |
| ETN-LDATSV45B | Shelf - 19" Standard Duty Sliding 1U x 450mm Deep | n/a | • | • | • |
| ETN-LDATSV55B | Shelf - 19" Standard Duty Sliding 1U x 550mm Deep | n/a | • | • | • |
| ETN-LDATSV70B | Shelf - 19" Standard Duty Sliding 1U x 700mm Deep | n/a | • | • | • |

Heavy Duty Sliding Shelves

These shelves are designed to mount into any EIA 310 compliant 19-inch rack. They can be used to support non rack mounted IT components such as monitors and modems. Perforated mounting surface provides tie down points.



Features / Benefits:

- Universal mount to EIA 310 compliant rails
- Load capacity 125kg evenly distributed (4 point mounting)
- Finished black
- Supplied with fixings and mounting instructions.

| Part Code | Description | Compatibility | | | |
|--------------|--|---------------|---------|----------|-----------|
| | | RE 2-Post | RE Rack | REC Rack | Universal |
| ETN-QRTSV45B | Shelf - 19" Heavy Duty Sliding 1U x 450mm Deep | n/a | • | • | • |
| ETN-QRTSV60B | Shelf - 19" Heavy Duty Sliding 1U x 600mm Deep | n/a | • | • | • |
| ETN-QRTSV75B | Shelf - 19" Heavy Duty Sliding 1U x 750mm Deep | n/a | • | • | • |



External Rack Upgrades

RE Series

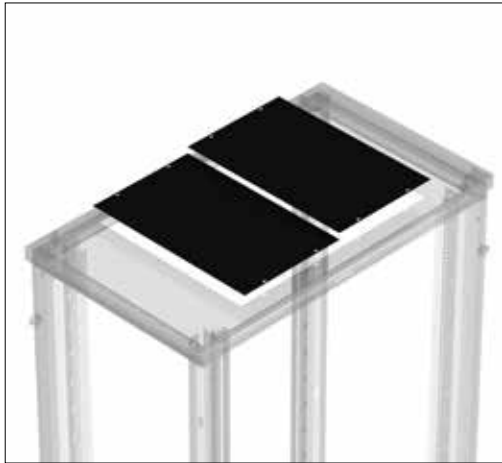

600mm Wide Rack



800mm Wide Rack

REC Series

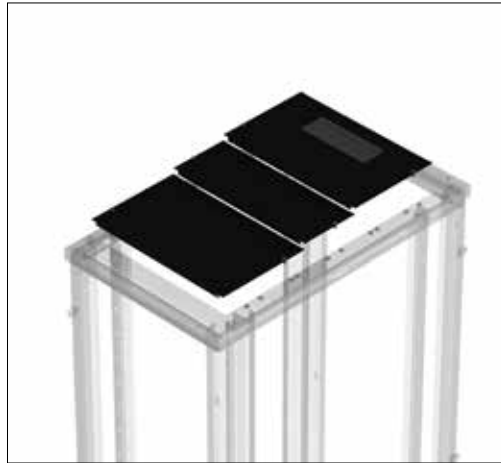

600mm Wide Rack



800mm Wide Rack

Front > Rear

| Part Code | Zone 1 | Zone 2 | Zone 3 |
|--------------|--------|--------|--------|
| REA27608SPBE | Plain | - | Plain |
| REB27608SPBE | Plain | - | Plain |
| REA27610SPBE | Plain | - | Plain |
| REA27808SPBE | Plain | - | Plain |
| REB27808SPBE | Plain | - | Plain |
| REA27810SPBE | Plain | - | Plain |
| REA42608SPBE | Plain | - | Plain |
| REA42608NPBE | Plain | - | Plain |
| REB42608SPBE | Plain | - | Plain |
| REA42610SPBE | Plain | - | Plain |
| REA42610NPBE | Plain | - | Plain |
| REA42808SPBE | Plain | - | Plain |
| REA42808NPBE | Plain | - | Plain |
| REB42808SPBE | Plain | - | Plain |
| REB42808NPBE | Plain | - | Plain |
| REA42810SPBE | Plain | - | Plain |
| REA42810NPBE | Plain | - | Plain |

Front > Rear

| Part Code | Zone 1 | Zone 2 | Zone 3 |
|--------------|--------|--------------|-------------|
| RCA42610SPBE | Plain | Plain Infill | Brush Entry |
| RCA42610NPBE | Plain | Plain Infill | Brush Entry |
| RCA42612SPBE | Plain | Plain | Brush Entry |
| RCA42612NPBE | Plain | Plain | Brush Entry |
| RCA42810SPBE | Plain | Plain Infill | Brush Entry |
| RCA42810NPBE | Plain | Plain Infill | Brush Entry |
| RCA42812SPBE | Plain | Plain | Brush Entry |
| RCA42812NPBE | Plain | Plain | Brush Entry |
| RCA47610SPBE | Plain | Plain Infill | Brush Entry |
| RCA47610NPBE | Plain | Plain Infill | Brush Entry |
| RCA47612SPBE | Plain | Plain | Brush Entry |
| RCA47612NPBE | Plain | Plain | Brush Entry |
| RCA47810SPBE | Plain | Plain Infill | Brush Entry |
| RCA47810NPBE | Plain | Plain Infill | Brush Entry |
| RCA47812SPBE | Plain | Plain | Brush Entry |
| RCA47812NPBE | Plain | Plain | Brush Entry |

RE & REC Top Panels

Using the default top panel configuration details on the previous page users can reconfigure the top of an RE or REC Series rack to suit their individual application requirements.

Some rack depths utilize smaller infill panels. Whilst the position of these panels can be moved the panels cannot be changed out for standard depth panels.

Features / Benefits:

- Finished black
- Supplied with fixings and mounting instructions.



| Part Code | Description | Compatibility | | | |
|--------------|--|---------------|---------|----------|-----------|
| | | RE 2-Post | RE Rack | REC Rack | Universal |
| ETN-FT2230LB | RE Series Top Panel 2-Way Fan Tray - 230VAC (1pcs) | n/a | • | • | n/a |
| ETN-EBSTPB | RE Series Top Panel Brush Entry Panel (1pcs) | n/a | • | • | n/a |
| ETN-EBSTPUKB | RE Series Top Panel Brush Entry Panel Upgrade Kit (1pcs) | n/a | • | • | n/a |
| ETN-TPBK8 | RE Series Top Panel 800W Side Brush Kits (2pcs) | n/a | n/a | • | n/a |
| ETN-VTP | RE Series Top Panel Vented Panel (1pcs) | n/a | • | • | n/a |

RE & REC Side Panels

RE and REC racks are available configured with or without side panels. Additional side panels are available allowing users to configure the rack security to requirements. Bayed racks can be configured with a single side panel between racks.

Features / Benefits:

- Key locking
- Single side panel secured bayed racks
- Finished black
- Supplied with fixings and mounting instructions.



| Part Code | Description | Compatibility | | | |
|--------------|---|---------------|---------|----------|-----------|
| | | RE 2-Post | RE Rack | REC Rack | Universal |
| RESSPU2708KB | RE Series Side Panel 27U x 800D (1pcs) | n/a | • | n/a | n/a |
| RESSPU2710KB | RE Series Side Panel 27U x 1000D (1pcs) | n/a | • | n/a | n/a |
| RESSPU4208KB | RE Series Side Panel 42U x 800D (1pcs) | n/a | • | n/a | n/a |
| RESSPU4210KB | RE Series Side Panel 42U x 1000D (1pcs) | n/a | • | • | n/a |
| RESSPU4212KB | RE Series Side Panel 42U x 1200D (1pcs) | n/a | n/a | • | n/a |
| RESSPU4710KB | RE Series Side Panel 47U x 1000D (1pcs) | n/a | • | • | n/a |
| RESSPU4712KB | RE Series Side Panel 47U x 1200D (1pcs) | n/a | n/a | • | n/a |

Accessories and Enhancements

Hardware & Other Accessories

RE & REC Rack Door Locking Upgrade Kits

This upgrade kits allows users to upgrade the locking option from a key locking swing handle to a mechanical combination lock with key override facility. The kit comprises of a pair of combination handles supplied complete with fitting and user instructions to upgrade a single rack unit.



Features / Benefits:

- Allows separate codes to be set for different rack location or groups of racks
- Completely retrofit-able
- Finished black
- Supplied with fitting and user and instructions.

| Part Code | Description | Compatibility | | | |
|------------|------------------------------|---------------|---------|----------|-----------|
| | | RE 2-Post | RE Rack | REC Rack | Universal |
| ETN-RECLUK | Combination Lock Upgrade Kit | n/a | • | • | n/a |

Castor Kits

A number of the standard RE and REC rack configurations include factory fitted transit castor. For racks supplied without castors this upgrade kits allows the racks to be retro fitted with castors. RE and REC racks castors provide a combined dynamic load rating of 200kg.



Features / Benefits:

- Combined dynamic load rating of 200kg
- Supplied with fixings and mounting instructions.

| Part Code | Description | Compatibility | | |
|-----------|-----------------------------|---------------|------------|-----------|
| | | RE Series | REC Series | Universal |
| ETN-CK | RE Series Castor Kit (4pcs) | • | • | n/a |

RE & REC Plinth Kits

Each plinth kit comprises of a pair of side kick plates along with front and rear kick plates. The plinth kits mount to the base of any RE or REC rack platforms using 1/4 turn snap on fixings. The kick plates help close off the gap between the rack and the floor, particularly when castors are fitted.



Features / Benefits:

- Easily fitted and removed
- Provides additional capacity for base entry incoming services
- Finished black
- Supplied with fixings and mounting instructions.

| Part Code | Description | Compatibility | | |
|--------------|-----------------------------------|---------------|------------|-----------|
| | | RE Series | REC Series | Universal |
| ETN-REPA608B | RE Series Plinth Kit 600W x 800D | • | n/a | n/a |
| ETN-REPA610B | RE Series Plinth Kit 600W x 1000D | • | • | n/a |
| ETN-REPA612B | RE Series Plinth Kit 600W x 1200D | n/a | • | n/a |
| ETN-REPA808B | RE Series Plinth Kit 800W x 800D | • | n/a | n/a |
| ETN-REPA810B | RE Series Plinth Kit 800W x 1000D | • | • | n/a |
| ETN-REPA812B | RE Series Plinth Kit 800W x 1200D | n/a | • | n/a |

RE & REC Rack Bolt Together / Baying Kit

Each RE and REC rack is configured with holes in the rack frame verticals allowing rows of same height racks to be bolted together for optimized stability and thermal efficiency. Racks of differing depths can be bolted together with racks levelled along the row.



Features / Benefits:

- Simple kit for easy site installation
- Helps optimize rack stability and thermal efficiency
- Can be used with side panels in place or removed
- Supplied with fixings and mounting instructions.

| Part Code | Description | Compatibility | | | |
|-----------|-----------------------------|---------------|---------|----------|-----------|
| | | RE 2-Post | RE Rack | REC Rack | Universal |
| ETN-BTK | RE Series Baying Kit (1pcs) | n/a | • | • | n/a |

Unit Height Labels

These self adhesive labels can be easily fitted to most 19-inch mounting rails and are especially suitable for all Eaton rack models. The labels help identify each equipment mounting "U", numbering equipment slots from bottom to top.



Features / Benefits:

- Self adhesive labels for easy mounting
- Numbered 1 - 47 bottom to top
- White background with black lettering for easy U identification
- Supplied with fixings and mounting instructions.

| Part Code | Description | Compatibility | | | |
|-----------|--|---------------|---------|----------|-----------|
| | | RE 2-Post | RE Rack | REC Rack | Universal |
| ETN-AUHLR | U-Height Labels - Bottom to Top (pair) | • | • | • | • |



Accessories and Enhancements

Hardware & Other Accessories

ePDU Mounting Kits

Designed to mount to the vertical styles of the RE and REC rack platforms the ePDU mounting kits allows Eaton's range of ePDUs to be optimally positioned in the rack space utilizing quick mount bobbins. Each mounting kit can accommodate two vertically mounted ePDUs.

Features / Benefits:

- 1 x Kit supplied as standard in REC racks
- Each kit accommodates up to two vertically mounted ePDUs
- Allows ePDUs to be clipped into position
- Supplied with fixings and mounting instructions.

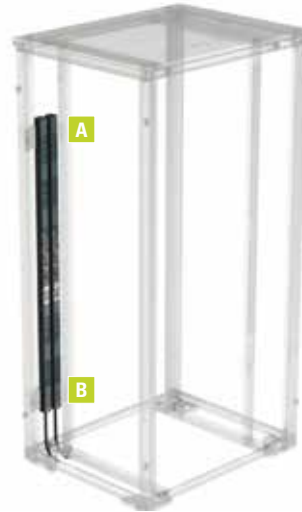

| Part Code | Description | Compatibility | | | |
|--------------|------------------------------------|---------------|---------|----------|-----------|
| | | RE 2-Post | RE Rack | REC Rack | Universal |
| ETN-REEPDUMK | RE Series ePDU Mounting Kit (pair) | n/a | • | • | n/a |

RE & REC Series Rack Earth Kit

Rack earth kits contain all the cable and fixings required to ground the rack components, providing earth continuity through the structure. Our earth kits are designed and tested in accordance with BS EN60950.



Features / Benefits:

- Supplied bagged for on-site installation
- Supplied complete with fitting instructions.

| Part Code | Description | Compatibility | | | |
|-----------|---------------------|---------------|---------|----------|-----------|
| | | RE 2-Post | RE Rack | REC Rack | Universal |
| ETN-EK | RE Series Earth Kit | • | • | • | n/a |

Universal Rack Earth Bar Kits

Eaton's 19-inch mounted earth bar kits can be fitted at any EIA 310 compliant rack. It takes up 1U of equipment mounting space and can easily be positioned in any available slot. Importantly our design ensures that the earth bar is isolated from the rack allowing the building clean earth to be directly connected. Connecting the equipment mounted in the rack to the earth bar ensure earth continuity and optimal operation of the infrastructure, particularly important with higher performance cabling systems.

Features / Benefits:

- Universal mount to all EIA 310 compliant rails
- 25 individual earth points
- Supplied complete with all applicable fixings for square pierced 19-inch rails
- Optional earth bar clamps are available (packs of 20).

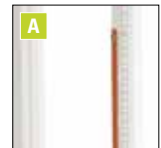
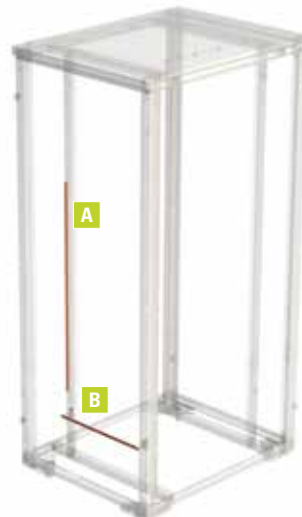

Vertical Earth Bar Assembly



19-Inch Earth Bar Assembly



Optional Earth Bar Clamps

| Part Code | Description | Compatibility | | | |
|------------|---|---------------|---------|----------|-----------|
| | | RE 2-Post | RE Rack | REC Rack | Universal |
| ETN-U19EBK | Universal Rack 19" Earth Bar Kit (1pcs) | • | • | • | • |
| ETN-EBK1 | Earth Bar Kit 1000mm (1pcs) | • | • | • | • |
| ETN-EBK2 | Earth Bar Kit 2000mm (1pcs) | • | • | • | • |
| ETN-EBIM | Earth Bar isolation mounts (2pcs) | • | • | • | • |
| ETN-EBL20 | Earth Bar Clamps (20pcs) | • | • | • | • |

Rack Thermal Management

Industry studies indicate that an estimated 60 percent of the cool air supplied to traditional data centers is wasted because it bypasses the intended IT equipment and returns directly to the hot air intake of the Computer Room Air Conditioner (CRAC).

Eaton's Airflow Management Solutions optimize power and cooling infrastructure, improve information processing density, create a greener data center and increase spatial flexibility for the data center manager all while saving money for our customers. Following some simple strategies can significantly improve operational efficiencies and lower the OPEX costs.

1. Adopting a room layout which sees racks aligned in hot and cold aisle configurations helps to avoid warm exhaust air being directly drawn into the air intake path of an adjacent rack.
2. Fitting 19-inch blanking panels in vacant equipment slots and deploying rack baffling helps to avoid recirculation in the rack space. Managing the segregation of the supply and return air helps to maximize the cooling infrastructure effectiveness by delivering air to the equipment intakes at the optimal temperature and volume.
3. Deploying cold or hot aisle containment strategy increases air efficiencies, allowing a significant reduction in cold air supply, enabling longer hardware life and valuable energy savings.

Eaton's containment solutions will significantly lower data center energy demands and associated energy costs. Eaton offers a wide range of partial and total containment solutions that can accommodate hot-aisle containment, cold aisle containment and rack-based heat containment. Eaton takes a consultative approach to helping our clients optimize solutions. Because each data center has its own unique issues, especially in relation to energy management, we do not advocate one containment concept over another. Rather, we work with data center professionals to audit current operations and then develop a comprehensive airflow management strategy that delivers the energy management control and savings that make the most sense for the facility in question.

The solution may be heat containment at the rack level, hot-aisle or cold-aisle containment. It might also be a combination of more than one of these approaches, depending on the layout of the data center. Whatever the need, Eaton has the expertise, flexibility and capacity to work with our customers, to not only provide them with a customized solution, but also to assist them in the stages leading up to total aisle containment. The result is improved data center operations and reduced energy consumption.

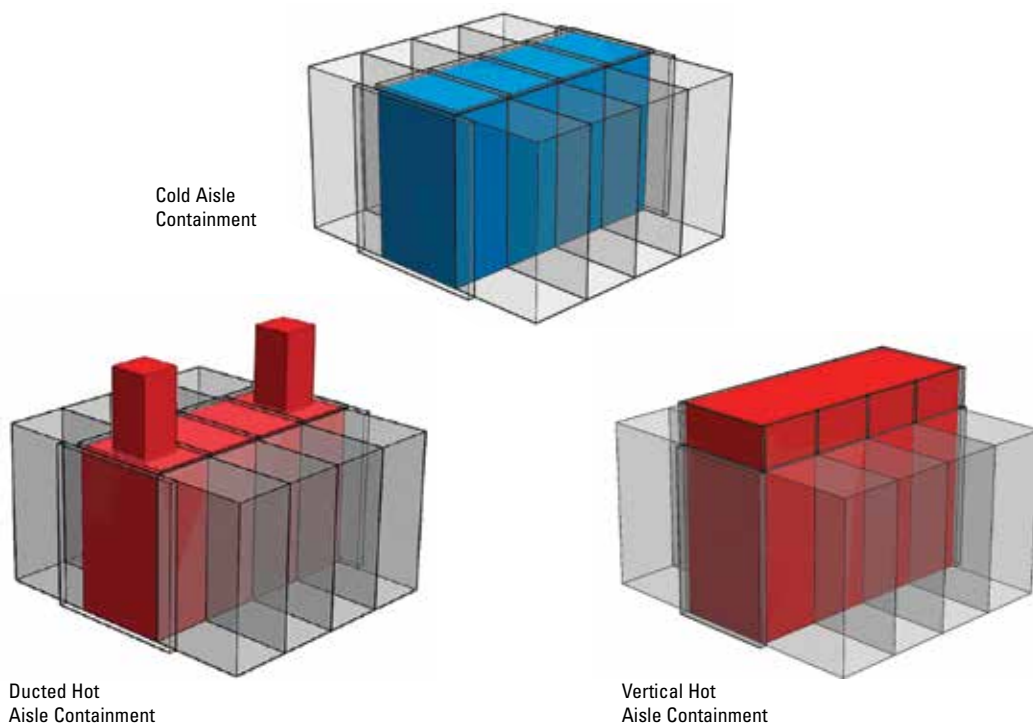

Accessories and Enhancements

Infrastructure Optimisation

Eaton offers a range of accessories and retrofit-able upgrades which provide users with the opportunity to optimize the rack and room environment according to installation demands and budget constraints. Many of these accessories can be used on rack platforms from multiple vendors (denoted "Universal").

Our solutions meet many of the "Best Practice" recommendations detailed in the **European Code Of Conduct on Data Center Energy Efficiency**. By managing the air segregation and optimization of air flow through a facility users can take advantage of lower operational costs or improved equipment capacity whilst minimising power consumption.

Temperature Strips

These simple self-adhesive labels have a scaled indicator which changes colour according to the localized air temperature. The labels allow users to see at a quick glance the current condition of the rack and help identify potential locations of concern.



Features / Benefits:

- Simple graphical indication of localized air temperature
- Temperature range 10°C - 40°C
- Labels measure 202mm x 18mm
- Durable self-adhesive backing.

| Part Code | Description | Compatibility | | | |
|---------------|----------------------------|---------------|---------|----------|-----------|
| | | RE 2-Post | RE Rack | REC Rack | Universal |
| WLTEMPSTRIP10 | Temperature strip (10pcs) | • | • | • | • |
| WLTEMPSTRIP | Temperature strip (100pcs) | • | • | • | • |

Floor Grommets

Eaton's floor grommets help to optimize the effectiveness of raised floor air delivery by helping to eliminate bypass airflow. Our range of floor grommets seal around the incoming services minimising air leakage, helping maintain the static pressure in the floor void.



Features / Benefits:

- Retrofit-able
- Maintains optimal underfloor static pressure
- Helps to reduce operational cost and maximize equipment densities
- Split design allows installation in live environments.

| Part Code | Description | Compatibility | | | |
|----------------|-------------------------------------|---------------|---------|----------|-----------|
| | | RE 2-Post | RE Rack | REC Rack | Universal |
| ETN-FLRGR118 | Floor Grommet 280mm x 210mm (1pcs) | n/a | n/a | n/a | • |
| ETN-FLRGR11810 | Floor Grommet 280mm x 210mm (10pcs) | n/a | n/a | n/a | • |
| ETN-FLRGR76 | Floor Grommet 190mm x 165mm (1pcs) | n/a | n/a | n/a | • |
| ETN-FLRGR7610 | Floor Grommet 190mm x 165mm (10pcs) | n/a | n/a | n/a | • |

In Rack Air Management / Blanking Options

Fitting 19-inch blanking panels in vacant equipment slots and deploying rack baffling helps to avoid recirculation in the rack space. Managing the segregation of the supply and return air helps to maximize the cooling infrastructure effectiveness by delivering air to the equipment intakes at the optimal temperature and volume.



600mm wide rack vertical air baffle



800mm wide rack vertical air baffle



Clip in plastic blanking panels available in 1U, 2U & 8U heights

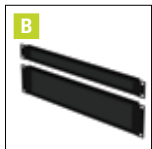

19-inch cable through blanking panels



PlenaFill® tear off blanking panels available in 27U sheets with clip in fixings

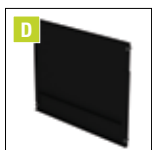

Adjustable height 19-inch blanking panels



Clip-in toolless 19-inch Blanking Panels

Designed to be used in any 19-inch compliant rack, these simple clip-in panels are available in a range of U heights and pack quantities. Quick and easy to deploy, these panels simply snap into position without the need for any tools.

19-inch blanking panels help avoid the mixing and recirculation of air in the rack space.

Features / Benefits:

- Clip-in toolless installation
- Universal 19-inch compliant (will fit 3rd party racks)
- Eaton branded.



| Part Code | Description | Compatibility | | |
|--------------|--|---------------|------------|-----------|
| | | RE Series | REC Series | Universal |
| ETN-PBP1U10 | 19" Blanking Panel - Clip-on Plastic 1U (10pcs) | • | • | • |
| ETN-PBP1U100 | 19" Blanking Panel - Clip-on Plastic 1U (100pcs) | • | • | • |
| ETN-PBP2U10 | 19" Blanking Panel - Clip-on Plastic 2U (10pcs) | • | • | • |
| ETN-PBP2U100 | 19" Blanking Panel - Clip-on Plastic 2U (100pcs) | • | • | • |
| ETN-PBP8U10 | 19" Blanking Panel - Clip-on Plastic 8U (10pcs) | • | • | • |
| ETN-PBP8U100 | 19" Blanking Panel - Clip-on Plastic 8U (100pcs) | • | • | • |

PlenaFill® Tear Off 19-inch Blanking Panels

Each sheet comprises of 27 off 1U tear-off blanking panels manufactured from UL-VO, class 94 fire retardant plastic. Users can simply tear the panel to the desired U height allowing simple and easy adaption to individual installation requirements.

Features / Benefits:

- Universal mount to all square pierced EIA 310 compliant rails
- Tear to unit height to suit application
- Quick fit mounting allowing fitting in seconds
- Fully re-usable
- Low weight.



| Part Code | Description | Compatibility | | |
|---------------|---|---------------|------------|-----------|
| | | RE Series | REC Series | Universal |
| ETN-PFBP27U1 | 19" Blanking Panel - 27U Tear Off PlenaFill® Kit (1pcs) | • | • | • |
| ETN-CBLPF-BR | 19" Blanking Panel - Snap Rivets Square Hole PlenaFill® (50pcs) | • | • | • |
| ETN-PFBP27U10 | 19" Blanking Panel - 27U Tear Off PlenaFill® Panels (10pcs) | • | • | • |

Adjustable Plain Steel 19-inch Blanking Panels

Available in a two height configurations, these sliding blanking panels are adjustable in height. Manufactured from painted mild steel these panels secure quickly to square pierced 19-inch mounting rails.

Features / Benefits:

- Universal mount to all square pierced EIA 310 compliant rails
- Fast tool-less 1/4 turn mounting
- Simple sliding height adjustment.



| Part Code | Description | Compatibility | | |
|------------|---|---------------|------------|-----------|
| | | RE Series | REC Series | Universal |
| SBP712USQ | 19" Blanking Panel - Adjustable Height Steel Panel 7U to 12U | • | • | • |
| SBP1222USQ | 19" Blanking Panel - Adjustable Height Steel Panel 12U to 22U | • | • | • |

Cable Pass Through 19-inch Blanking Panels

Available in 1U and 2U height options, these cable through panels allow cables to be passed through the 19-inch aperture without compromising in-rack air management. Toolless 1/4 mounting ensures the units can be mounted quickly and easily on any racks with EIA 310 compliant square pierced 19-inch rails.



Features / Benefits:

- Universal mount to all square pierced EIA 310 compliant rails
- Fast tool-less 1/4 turn mounting
- Cable through feature with brush seal.

| Part Code | Description | Compatibility | | | |
|-----------|--|---------------|---------|----------|-----------|
| | | RE 2-Post | RE Rack | REC Rack | Universal |
| ETN-OBSP1 | Blanking Panel 19" - Brush Cable Entry 1U (1pcs) | • | • | • | • |
| ETN-OBSP2 | Blanking Panel 19" - Brush Cable Entry 2U (1pcs) | • | • | • | • |

600mm Wide Rack Air Management Baffles

These baffle kits are designed to seal the gaps between the 19-inch rails and the rack frame and side panels. Baffle kits coupled with 19-inch blanking panels provide in-rack air management avoiding the mixing of supply and exhaust air to improve system efficiency and reduce operating costs.



Features / Benefits:

- Retrofit-able
- Easy to install
- Promotes optimal air flow through the rack space
- Helps to lower operational costs and facilitate higher equipment densities.

| Part Code | Description | Compatibility | | | |
|--------------|---|---------------|---------|----------|-----------|
| | | RE 2-Post | RE Rack | REC Rack | Universal |
| RESABK4206KB | RE Series Airflow Baffle Kit - 42U x 600W | n/a | • | • | n/a |
| RESABK4706KB | RE Series Airflow Baffle Kit - 47U x 600W | n/a | • | • | n/a |

800mm Wide Rack Air Management Baffles

Like the 600mm wide baffle kits, these baffles are designed to seal the gaps between the 19-inch rails and the rack frame and side panels. Grommets are strategically positioned up each vertical baffle to allow multiple cable pass through points. Baffle kits coupled with 19-inch blanking panels provide in-rack air management avoiding the mixing of supply and exhaust air to improve system efficiency and reduce operating costs.



Features / Benefits:

- Retrofit-able
- Easy to install
- Incorporates multiple cable through apertures with sealing grommets
- Promotes optimal air flow through the rack space
- Helps to lower operational costs and facilitate higher equipment densities.

| Part Code | Description | Compatibility | | | |
|--------------|---|---------------|---------|----------|-----------|
| | | RE 2-Post | RE Rack | REC Rack | Universal |
| RESABK4208KB | RE Series Airflow Baffle Kit - 42U x 800W | n/a | • | • | n/a |
| RESABK4708KB | RE Series Airflow Baffle Kit - 47U x 800W | n/a | • | • | n/a |
| ETN-ACCGROM | Oval Grommet - 38mm x 100mm (10pcs) | n/a | • | • | n/a |

Eaton's Aisle Containment System for the REC Series IT racks delivers energy saving airflow management for small to medium data center applications

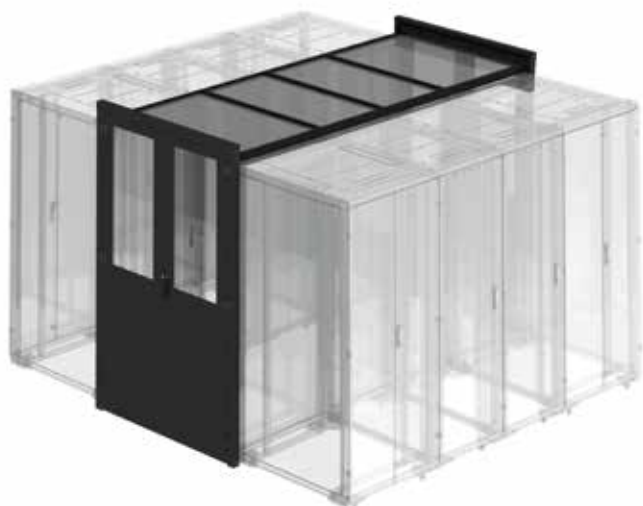

Designed for fast and easy installation, the REC aisle containment system provides an affordable solution for energy saving cold aisle containment installations. This completely modular system allows extensions or reconfigurations as a pod changes or expands.

The system attaches to 42U or 47U high Eaton REC Series racks, and spans 1200mm wide aisles. Roof panels connect to equal-width racks on either side of the aisle, and can be cut to install fire suppression systems.

Importantly, the REC aisle containment system provides an energy saving envelope for Eaton's new Intelligent Power Pod™ platform, which includes UPSs, rack PDUs, power management software, services and IT racks. With this full suite of products, integrators can simply install their preferred IT equipment and software and deliver a fully integrated system to their customer.

End-of-Row door kits include:

- Split, swing-style door pre-assembled with toughened glass window
- Door frame
- All hardware to attach doors to IT racks and floor.

Roof panel kits include:

- Acrylic panel
- Panel frame with Velcro™ seal
- All hardware to attach panels to racks and adjacent roof panels.

| Rack Height | End Of Row Doors | | Roof Panels | |
|---|--|-------------------|-----------------|-----------------|
| | 42U | 47U | - | - |
| Height (mm) | 2138 | 2367 | - | - |
| Width (mm) | 1316 | 1316 | 600 | 800 |
| Depth (mm) | 53 | 53 | 1200 | 1200 |
| Aisle Width (mm) | 1200 | 1200 | 1200 | 1200 |
| Door Style | Split swing doors | Split swing doors | - | - |
| Door opening angle / hinges | 180°, 2 off lift off hinges | | | |
| Door window material | Clear toughened glass, 4mm thick | | | |
| Roof panel material | 3mm thick clear Perspex cast acrylic, attached with Velcro™ | | | |
| Roof panels—Standards & Classifications | UL94 HB, NFP 92-307 (dripless), BS 476 Part 7 Class 3 | | | |
| Rack Types | Doors and roof panels designed for Eaton REC series IT racks | | | |
| Colour - Door & Frame | Black, RAL 9005 | | | |
| Estimated Installation Time | 4 hours each | 4 hours each | 10 minutes each | 10 minutes each |
| Weight (kg) | 56 | 62 | 8.8 | 11.2 |
| Part Code | RCACUHD12KB | RCACUHD12KB | RCACRP0612KB | RCACRP0812KB |

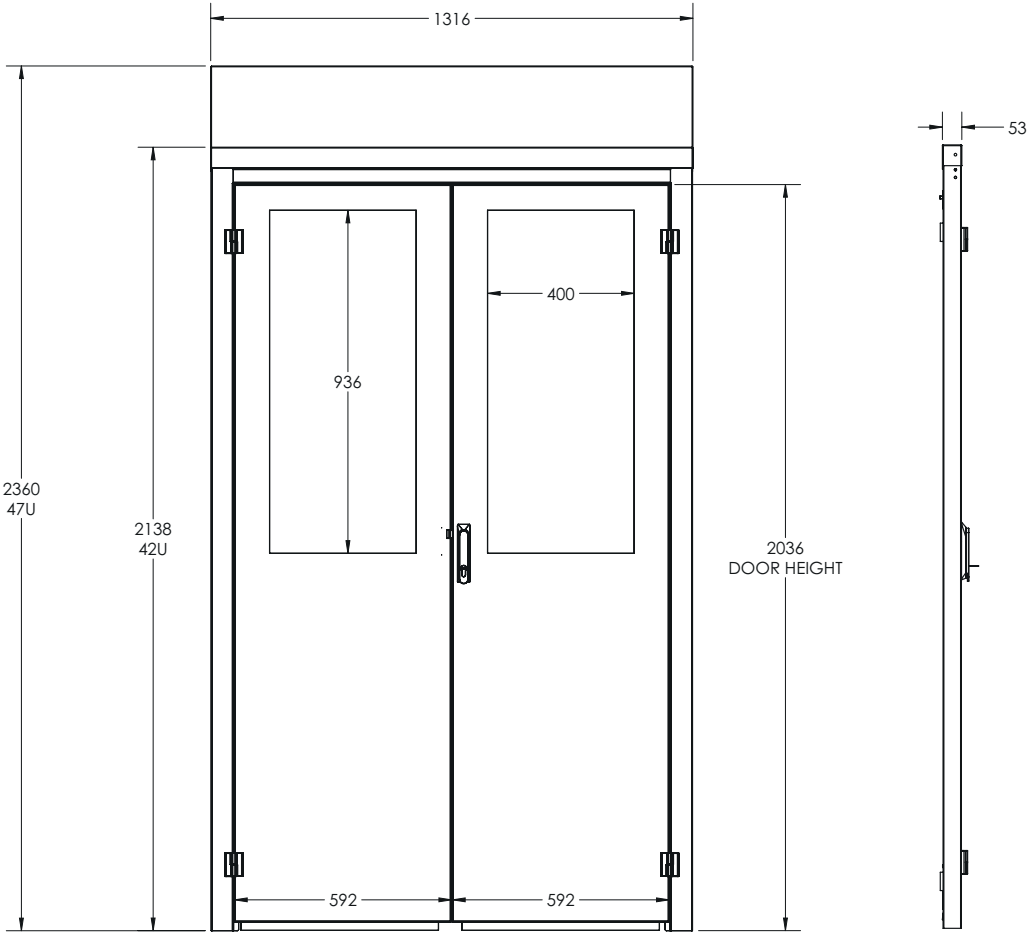

End-of-row door dimensions

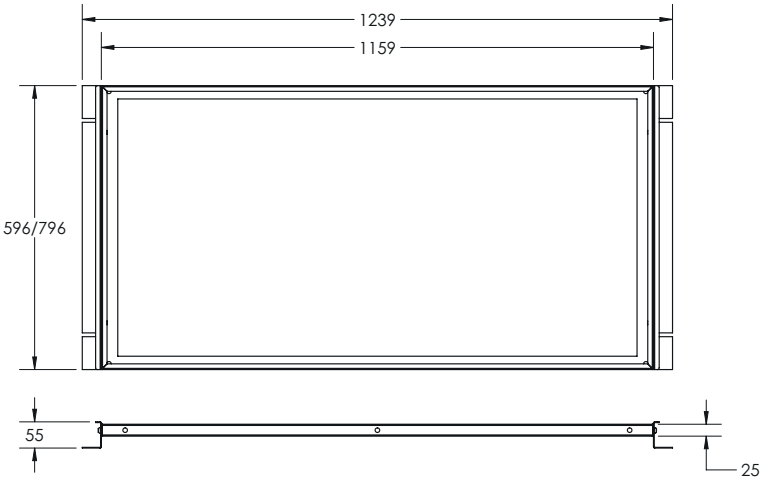

Roof panel dimensions

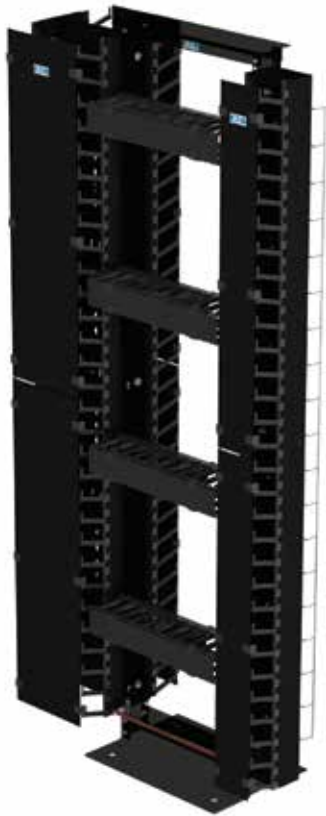

RE Series 2-Post Rack

A simple mounting frame solution to house IT equipment whilst providing maximum cabling access and capacity. Eaton's RE Series 2-Post Rack platform is ideally suited to telecommunication rooms where volume copper or fibre cabling systems are usually deployed. The open access design enables easy installation of equipment and provides a secure connectivity solution for all internationally recognized cabling standards, including CAT 8.

Designed to be easily assembled on site, each frame is shipped flat-packed for simple on-site installation.

Also available is a range of complementary horizontal and vertical cable management accessories. These provide users with the tools to configure the system to match individual applications.

Features / Benefits:

- Easy bolt together construction
- 45U Standard height
- Range of vertical, horizontal and cable spool management options and configurations
- Robust pre-drilled floor mounting base (bolts not supplied)
- Black powder coat finish
- Supplied in simple kit form for easy on-site assembly.



Adjustable depth cable spools



High Density vertical cable managers with clip on split covers. Available in 140mm & 280mm widths



High density horizontal cable managers. 1U, 2U and 3U options



19-inch mounted earth bar kit



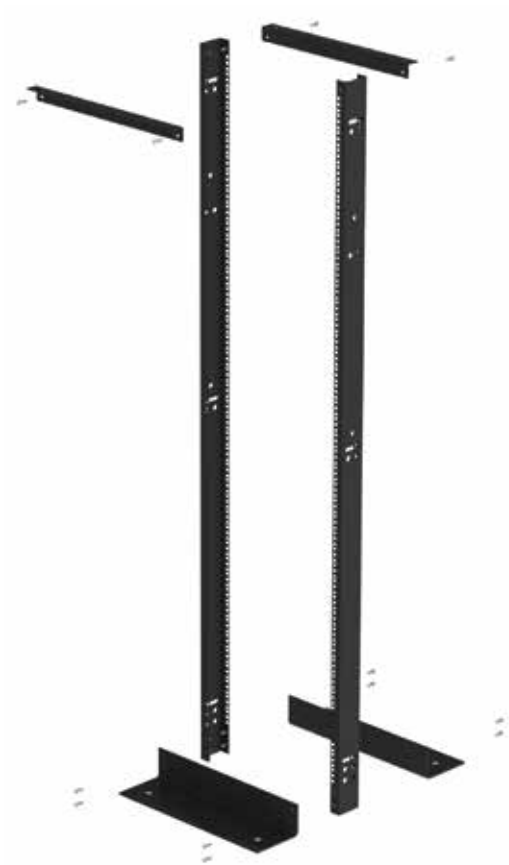

Supplied in kit









After assembly

Eaton's RE Series 2-Post Rack is an open rack frame available in 45U height which suits most applications. Designed to be easily assembled on site, each frame is shipped flat-packed for simple and quick assembly and installation

All RE 2-Post Racks Include:

- 2 x vertical 19" members
- 2 x pre drilled base mounting angles (no bolts supplied)
- 2 x top support angles
- 1 x PDU Mounting Brackets (Pair)
- Black finish
- Supplied in simple kit form for easy on-site assembly.

RE 2-Post Rack – Example configurations:

| | |
|--|--|
|  | Frame with single cable manager |
|  | Frame with two single cable managers mounted front and rear |
|  | Frame with single cable manager and cable basket manager to rear |
|  | Frame with single cable manager and internal double cable manager |
|  | Frame with two single cable managers to the side, mounted front and rear, and two internal double cable managers, mounted front and rear |
|  | Frame with single cable manager and internal double cable manager with cable basket managers to rear |



Technical Specifications

| | |
|------------|-------------|
| Order Code | RE2PRFK45UB |
|------------|-------------|

Physical

| | |
|-------------------------------|--|
| Equipment Mounting Height | 45U |
| Height (mm) | 2134 |
| Width (mm) | 516 |
| Depth of Mounting Base (mm) | 381 |
| Weight (kg) | 20.4 |
| Weight Capacity (Static) (kg) | 750 |
| Rail Mounting Width (mm) | 482.6 (19") fully compliant to EIA-310-E |
| Colour | Black RAL 9005 powder coat |

Active Equipment Management

| | |
|-----------------------|--|
| Heat Load Suitability | By nature an open structure rack limits the opportunity to optimise the management of air to active equipment. Therefore equipment heat load densities will be governed by the provision of cooling in the room. |
|-----------------------|--|

Conformance

| | |
|----------------------|-------------------------------------|
| Regulatory Approvals | IEC/EN 60950, IEC/EN 60297, IEC 529 |
| Standards | EIA-310-E compliant |

Shipping: Supplied flat packed.

Customer Service & Support

| | |
|----------|---------|
| Warranty | 2 Years |
|----------|---------|

Note: Due to continuous product improvement programs specifications are subject to change without notice.

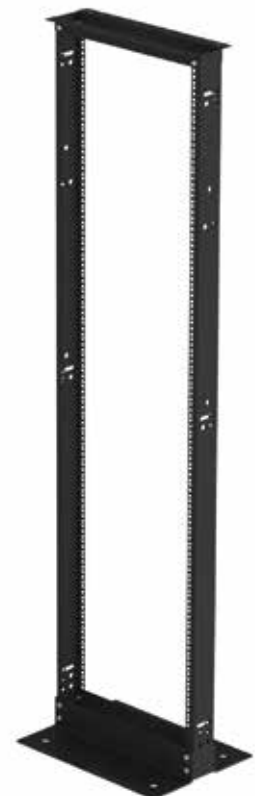



High Density Vertical Cable Managers

Eaton's open rack vertical cable managers are available in two standard widths. The managers are designed to bolt to the sides of the RE 2-Post Rack frame and can be configured either in single or double configurations. Units are supplied complete with dual hinged split covers for ease of operation and improved cable management.

Features / Benefits:

- 2 width options; 140mm or 280mm
- 1 x vertical manager
- 2 x dual hinged covers
- Mounting instructions & fixings
- Black finish RAL9005
- Supplied in simple kit form for easy on-site assembly.



| Part Code | Description | Compatibility | | | |
|----------------|--|---------------|---------|----------|-----------|
| | | RE 2-Post | RE Rack | REC Rack | Universal |
| RE2PRMK45U140B | 45U x 140mm Wide HD Cable Manager (1pcs) | • | n/a | n/a | n/a |
| RE2PRMK45U280B | 45U x 280mm Wide HD Cable Manager (1pcs) | • | n/a | n/a | n/a |

Vertical Cable Basket Kits

Designed to mount on the rear of the RE 2-Post Rack vertical cable managers, these basic sections can be configured to offer rear, side or forward facing management options.

Features / Benefits:

- 1 x vertical basket manager
- 3 width options; 100mm, 200mm or 300mm
- Mounting hardware
- 2 x dual hinged covers
- Mounting instructions & fixings
- Black finish
- Supplied in simple kit form for easy on-site assembly.

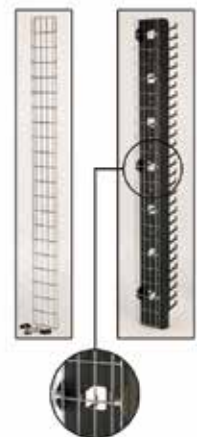

| Part Code | Description | Compatibility | | | |
|----------------|---|---------------|---------|----------|-----------|
| | | RE 2-Post | RE Rack | REC Rack | Universal |
| RE2PRBK45U100B | 45U x 100mm Wide Vertical Cable Basket (1pcs) | • | n/a | n/a | n/a |
| RE2PRBK45U200B | 45U x 200mm Wide Vertical Cable Basket (1pcs) | • | n/a | n/a | n/a |
| RE2PRBK45U300B | 45U x 300mm Wide Vertical Cable Basket (1pcs) | • | n/a | n/a | n/a |

High Density 19-inch Horizontal Managers

Horizontal cable managers are available in heights of 1U, 2U & 3U. The depth of the unit allows for higher density cabling. The design allows cables to be transitioned across the rack space, front to rear through the 19-inch aperture and above and below the managers to adjacent devices or patch panels.



Features / Benefits:

- Universal mount to EIA 310 compliant rails
- Promotes cable bend radius control
- Clip-on hinged covers hide cable tails
- Unit depth 150mm
- Finished black.

| Part Code | Description | Compatibility | | | |
|--------------|---|---------------|---------|----------|-----------|
| | | RE 2-Post | RE Rack | REC Rack | Universal |
| ETN-HDHCM1UB | 1U High Density Horizontal 19" Cable Manager (1pcs) | • | • | • | • |
| ETN-HDHCM2UB | 2U High Density Horizontal 19" Cable Manager (1pcs) | • | • | • | • |
| ETN-HDHCM3UB | 3U High Density Horizontal 19" Cable Manager (1pcs) | • | • | • | • |

Universal Rack 19" Earth Bar Kit

Eaton's 19-inch mounted earth bar kits can be fitted at any EIA 310 compliant rack. It takes up 1U of equipment mounting space and can easily be positioned in any available slot. Importantly our design ensures that the earth bar is isolated from the rack allowing the building clean earth to be directly connected. Connecting the equipment mounted in the rack to the earth bar ensure earth continuity and optimal operation of the infrastructure, particularly important with higher performance cabling systems.



Features / Benefits:

- Universal mount to all EIA 310 compliant rails
- 25 individual earth points
- Supplied complete with all applicable fixings for square pierced 19-inch rails
- Optional earth bar clamps are available (packs of 20).

| Part Code | Description | Compatibility | | | |
|------------|---|---------------|---------|----------|-----------|
| | | RE 2-Post | RE Rack | REC Rack | Universal |
| ETN-U19EBK | Universal Rack 19" Earth Bar Kit (1pcs) | • | • | • | • |
| ETN-EBL20 | Earth Bar Clamps (20pcs) | • | • | • | • |

Adjustable Cable Spool

The adjustable cable spools provides support and anchor points for managing changes in multiple cable directions. The spools are designed to mount onto the sides of the RE 2-Post Rack frames.



Features / Benefits:

- Tool-less adjustment from 127mm—203mm
- Promotes cable bend radius control
- Finished black.

| Part Code | Description | Compatibility | | | |
|---------------|-------------------------------|---------------|---------|----------|-----------|
| | | RE 2-Post | RE Rack | REC Rack | Universal |
| ETN-SB860ACSF | Adjustable Cable Spool (1pcs) | • | • | • | n/a |



Feature

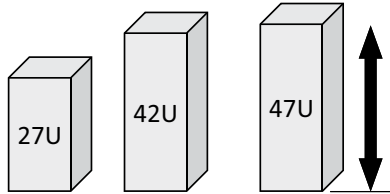

Rack Heights

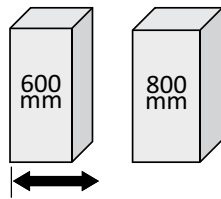

Rack Widths

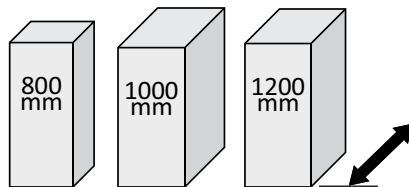

Rack Depths

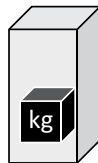

Rack Loading

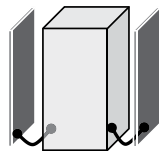

Rack Grounding

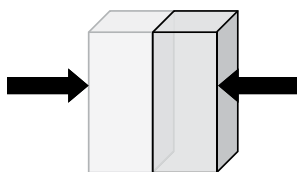

Rack Baying

27U is typically used in an office type environment. For a data closet application it makes sense to maximize the use of floor space & future proof the installation by deploying taller racks. Ensure you have sufficient clearance for the rack in the room!

| | RE Rack | REC Rack |
|-----|---------|----------|
| 27U | • | n/a |
| 42U | • | • |
| 47U | • | • |

Note: 1U = 44.45mm.

Typically 800mm wide racks are used for cabling racks (passive), racks where switches are mounted (some switches draw air across the switch to cool them) & higher density active racks where multiple ePDUs may be required to support the equipment.

| | RE Rack | REC Rack |
|-------|---------|----------|
| 600mm | • | • |
| 800mm | • | • |

For cabling applications an 800mm deep rack is often sufficient. For mixed technologies or modern active equipment applications, racks should ideally be 1000mm deep as a minimum. 1200mm deep racks help future proof an installation providing space of active equipment & multiple supporting ePDUs.

| | RE Rack | REC Rack |
|--------|---------|----------|
| 800mm | • | • |
| 1000mm | • | • |
| 1200mm | n/a | • |

If the rack is likely to be moved to location, loaded with equipment and left in place then you only need to consider the static load rating. If the rack is going to be moved around after the equipment is fitted then you need to consider the rack dynamic load rating (limited by the castors or wheels).

| | RE Rack | REC Rack |
|--------------------|---------|----------|
| Static: 800kg | • | n/a |
| Dynamic: 250kg | | |
| Static: 1,100kg | n/a | • |
| Dynamic: 250kg | | |

Racks contain powered equipment which under fault conditions may short out on the rack structure. For safety reasons the assembly should be designed to provide earth continuity through component parts with some parts requiring the fitting of earth bonding leads. The Eaton platforms below include earth bonding / grounding kits as standard.

| | RE Rack | REC Rack |
|--------------------------|---------|----------|
| Rack Grounding Kit | • | • |

Where multiple racks are positioned side by side it is good practice to bolt the racks together to ensure the racks are aligned. Bolting the racks together also helps to avoid racks tipping over when equipment is slid out of the rack. Eaton's rack platforms below have facilities to bolt the rack down to help avoid tip issues.

| | RE Rack | REC Rack |
|---|---------|----------|
| Rack Baying or Bolt Together Kit | • | • |

Feature

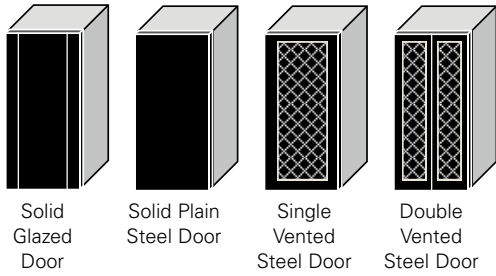

Solid Doors

Vented Doors

Double Vented Doors

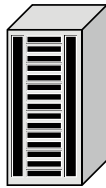

In Rack Air Management

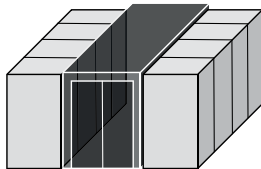

Standard Aisle Containment

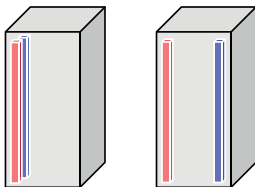

Power Distribution

These provide the lowest cost option & are fine for use where low levels of active equipment (<1.5kW) or passive equipment are mounted in the rack. They provide a clear view of equipment & slightly higher levels of security with higher levels of noise reduction.

| | RE Rack | REC Rack |
|------------------|---------|----------|
| Glazed Front | • | n/a |
| Plain Steel Rear | • | n/a |

Most active equipment designs use air to cool the internal components. Getting sufficient air into & out of the rack stops the equipment from overheating & failing. Vented doors enable racks to support heat loads of around 4kW (assumes air is conditioned in the room).

| | RE Rack | REC Rack |
|---------------------|---------|----------|
| Single Vented Steel | • | • |

Like the vented doors these are used to help avoid active equipment overheating. Double doors are particularly useful where the space behind an 800mm wide rack is limited (narrow aisle or tight to a wall).

| | RE Rack | REC Rack |
|---------------------|-----------------|-----------------|
| Double Vented Steel | • 800mm wide | • 800mm wide |

Avoiding mixing the cold supply air coming into the front of the rack with the warm return air being exhausted by the active equipment helps improve cooling efficiency. Fitting vertical baffle (to close off the space between the 19-inch rails and the rack side) together with the fitting of 19-inch blanking panels helps to optimize rack cooling efficiency.

| | RE Rack | REC Rack |
|--------------|---------|----------|
| Baffle Kits | • | • |
| 19" Blanking | • | • |

This is a method of enclosing the space between two rows of adjacent racks. Normally comprising of end of aisle doors & over aisle roof panels, the enclosed space between the rows of racks is used to contain the cold supply air or the hot return air. This helps to maximize the cooling effect of the supply air & provide uniform air delivery.

| | RE Rack | REC Rack |
|-------------------|---------|----------|
| Aisle Containment | - | • |

Very often the rack will contain active equipment requiring a power connection in the rack. The Eaton rack platforms below include the provision to mount Eaton's ePDU solutions in the rear of the rack space with additional mounting kits available as an accessory.

| | RE Rack | REC Rack |
|------------------------|------------|------------|
| ePDU Mounting Brackets | • (std) | • (std) |

Rack Configuration

Handy Hints



| Application | 2-Post Racks | RE Racks | | REC Racks | | REC Racks & Containment |
|---------------------------|--------------|----------|--------|-----------|--------|-------------------------|
| | | Basic | Active | Basic | Active | |
| Network Hosting 0 - 1.5kW | - | ■ | ■ | ■ | ■ | ■ |
| Server Hosting 1.5 - 3kW | - | - | ■ | - | ■ | ■ |
| Server Hosting 3 - 5kW | - | - | ■ | - | ■ | ■ |
| Switch Hosting 1 - 1.5kW | ■ | ■ | ■ | ■ | ■ | ■ |
| Switch Hosting 1.5 - 3kW | ■ | - | ■ | - | ■ | ■ |
| Switch Hosting 3 - 5kW | ■ | - | ■ | - | ■ | ■ |
| Cabling Hosting | ■ | ■ | ■ | ■ | ■ | ■ |
| Network Hosting 0 - 1.5kW | - | ■ | ■ | ■ | ■ | ■ |
| Server Hosting 1.5 - 3kW | - | - | ■ | - | ■ | ■ |
| Server Hosting 3 - 5kW | - | - | ■ | - | ■ | ■ |
| Switch Hosting 1 - 1.5kW | ■ | ■ | ■ | ■ | ■ | ■ |
| Switch Hosting 1.5 - 3kW | ■ | - | ■ | - | ■ | ■ |
| Switch Hosting 3 - 5kW | ■ | - | ■ | - | ■ | ■ |
| Cabling Hosting | ■ | ■ | ■ | ■ | ■ | ■ |
| Network Hosting 0 - 1.5kW | - | ■ | ■ | ■ | ■ | ■ |
| Server Hosting 1.5 - 3kW | - | - | ■ | - | ■ | ■ |
| Server Hosting 3 - 5kW | - | - | ■ | - | ■ | ■ |
| Switch Hosting 1 - 1.5kW | ■ | ■ | ■ | ■ | ■ | ■ |
| Switch Hosting 1.5 - 3kW | ■ | - | ■ | - | ■ | ■ |
| Switch Hosting 3 - 5kW | ■ | - | ■ | - | ■ | ■ |
| Cabling Hosting | ■ | ■ | ■ | ■ | ■ | ■ |
| Network Hosting 0 - 1.5kW | - | n/a | n/a | ■ | ■ | ■ |
| Server Hosting 1.5 - 3kW | - | n/a | n/a | - | ■ | ■ |
| Server Hosting 3 - 5kW | - | n/a | n/a | - | ■ | ■ |
| Switch Hosting 1 - 1.5kW | ■ | n/a | n/a | ■ | ■ | ■ |
| Switch Hosting 1.5 - 3kW | ■ | n/a | n/a | - | ■ | ■ |
| Switch Hosting 3 - 5kW | ■ | n/a | n/a | - | ■ | ■ |
| Cabling Hosting | ■ | n/a | n/a | ■ | ■ | ■ |

■ Recommended & Fully Compatible ■ Available & Compatible



Intelligent infrastructure for IT rooms and data centers



By complimenting Eaton IT racks with other products from Eaton's wide product portfolio, you can build a complete physical infrastructure for your IT rooms and data centers as well as monitor and manage it from your virtualization dashboard.

Ensure power protection of your IT equipment with Eaton rack based UPSs. Organize power distribution to individual IT appliances through intelligent rack power distribution units and monitor your entire power infrastructure through your existing virtualization dashboard by simply plugging in Eaton's power management software. The software will also help trigger pre-defined disaster recovery policies in case of power and environmental events.

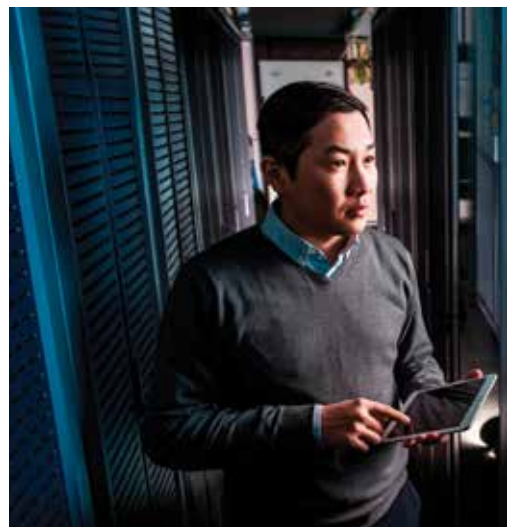

Power protection

To protect your IT equipment installed in the IT rack, Eaton offers a range of highly effective Energy Star qualified rack-based UPS solutions. In combination with Eaton's Intelligent Power Software, Eaton UPSs can be monitored and managed from your virtualization dashboard – initiating disaster recovery policies in the event of an alarm.



Eaton 5PX UPS 1500-3000 VA

The Eaton 5PX Rack/Tower UPS provides line-interactive backup power and scalable runtimes for servers, storage systems, VoIP gear and network equipment.

Eaton 9PX UPS 1000-3000W

The Eaton 9PX UPS (1000-3000 W) provides advanced protection for small & medium datacenters, IT rooms and Infrastructure. Delivering double conversion protection and being the first in its class to provide Unity power factor (VA=W).

Eaton 9PX UPS 5-22 kVA

The Eaton 9PX UPS (5-22 kVA) provides energy-efficient power protection for small & medium data centers, IT rooms and infrastructure. Delivering double conversion protection with 40% less energy usage and 28% more power. 9PX is the perfect UPS for IT and Facility managers who are concerned by energy cost and are looking for next generation power protection solutions.



Power distribution

While a UPS protects your IT application, power distribution takes care that the power from the UPS is distributed between IT appliances you have in your rack. The next generation of Eaton advanced rack PDUs (ePDU G3) incorporate monitoring and management capabilities. In addition to distributing power from the UPS to your IT appliances safely and efficiently, modern distribution units will enable you to monitor and measure power consumption in an IT rack, remotely shut down power during an outage and help initiate disaster recovery policies.



Eaton ePDU G3 Basic

Models available in 0U and 1U

Designed for reliable and cost effective power distribution, the ePDU G3 Basic models feature Eaton's patented IEC outlet grip plug retention, color-coded outlet sections, a low-profile form factor and a high operating temperature. 0U models include both rear and side button mounting systems as well as Eaton's patented variable mounting system.



Eaton ePDU G3 In-Line Metered and Dual

Add metering to upgrade basic PDUs

ePDU G3 In-Line Metered models allow existing basic PDUs to be upgraded to include IEC class 1 billing grade metering and can be mounted either horizontally in the rack or vertically on the 0U space. Models include IEC Class 1 ($\pm 1\%$) billing grade accuracy, an advanced hot-swap meter with LCD pixel display showing V, W, A and kWh and the ability to daisy chain 8 ePDUs to share the same network connection and IP address.



Eaton ePDU G3 Metered Input

Models available in 0U, 1U and 2U

ePDU G3 Metered Input models allow metering to the branch and phase level for effective load balancing, with no switching. Models include IEC Class 1 ($\pm 1\%$) billing grade accuracy, an advanced hot-swap meter with LCD pixel display showing V, W, A and kWh, and the ability to daisy chain 8 ePDUs to share the same network connection and IP address.





Eaton ePDU G3 Metered Outlet

Meter the input, branch, individual outlets & IT equipment across A and B feed

ePDU G3 Metered Outlet models allow device level metering over multiple power feeds and includes kWh, peak power and current draw. Analyze and understand the consumption of individual devices powered over A and B feeds and view available power. Metered Outlet units have no switching. They include IEC Class 1 ($\pm 1\%$) billing grade accuracy, an advanced hot-swap meter with LCD pixel display showing V, W, A and kWh, and the ability to daisy chain 8 ePDUs to share the same network connection and IP address.



Eaton ePDU G3 Switched

Switch outlets & IT equipment across A and B feed + meter the input and branch circuits

ePDU G3 Switched models allow lights-out control of devices including switching devices powered across multiple ePDUs. They include IEC Class 1 ($\pm 1\%$) billing grade accuracy, an advanced hot-swap meter with LCD pixel display showing V, W, A and kWh and the ability to daisy chain 8 ePDUs to share the same network connection and IP address.



Eaton ePDU G3 Managed

Switch and meter outlets & IT equipment across A and B feed:

Combines both Switched and Metered Outlet functionality together in one ePDU

ePDU G3 Managed models allow complete lights-out control and metering of devices including devices that are powered across multiple ePDUs. They include IEC Class 1 ($\pm 1\%$) billing grade accuracy, an advanced hot-swap meter with LCD pixel display showing V, W, A and kWh and the ability to daisy chain 8 ePDUs to share the same network connection and IP address.



Eaton ATS 16 & ATS 30

The Eaton ATS offers an affordable solution for customers willing to add power redundancy to networking equipment like switches and routers. This automatic transfer switch will power them from two different sources. Should one power source fail, the alternate one will switch over with no interruption to the connected equipment. Eaton ATS can be connected to multiple devices at the same time while saving the cost of expensive redundant power supplies.

Power management

Eaton's Intelligent Power Manager (IPM) software integrates with leading virtual machine management systems such as VMware vCenter, Citrix XenCenter, Microsoft SCVMM and RedHat and provides the tools needed to monitor and manage power equipment in your physical and virtual environments. IPM allows you to easily define business continuity policies to keep your IT devices up and running during power and environmental events. This innovative software solution ensures system uptime and data integrity by allowing you to remotely monitor, manage and control devices on your network.

In addition, Eaton's Microsoft SCOM management pack makes it possible to monitor Eaton UPSs directly within Microsoft Systems Center Operations Manager, while Eaton's Infrastructure Management Pack for VMware vRealize® helps monitor and manage the health, risk and efficiency of power devices through vRealize dashboard.



Data center infrastructure monitoring

Embedded within an Eaton Intelligent Power Controller, the new IPM Infrastructure software provides data center managers with an easy to use and simple to deploy infrastructure monitoring solution. From the rack view to the data center dashboard, IPM Infrastructure allows IT professionals to understand and monitor data center power, environmental and physical capacity metrics, all within the context of their IT infrastructure. With the flexibility of the 42iTy™ Open Source data center monitoring software stack, Eaton IPM Infrastructure simplifies complexity of multilayered software-defined data centers.



Eaton is dedicated to ensuring that reliable, efficient and safe power is available when it's needed most. With unparalleled knowledge of electrical power management across industries, experts at Eaton deliver customised, integrated solutions to solve our customers' most critical challenges.

Our focus is on delivering the right solution for the application. But, decision makers demand more than just innovative products. They turn to Eaton for an unwavering commitment to personal support that makes customer success a top priority.

For more information, visit www.eaton.eu/electrical

www.eaton.eu/powerquality

Eaton
EMEA Headquarters
Route de la Longeraie 7
1110 Morges, Switzerland
Eaton.eu

© 2016 Eaton
All Rights Reserved
Printed in Europe
Publication No. CA159001EN
Article Rack Selection Guide, Rev A
September 2016

Changes to the products, to the information contained in this document, and to prices are reserved; so are errors and omissions. Only order confirmations and technical documentation by Eaton is binding. Photos and pictures also do not warrant a specific layout or functionality. Their use in whatever form is subject to prior approval by Eaton. The same applies to Trademarks (especially Eaton, Moeller, and Cutler-Hammer). The Terms and Conditions of Eaton apply, as referenced on Eaton Internet pages and Eaton order confirmations.

Eaton is a registered trademark.
All other trademarks are property of their respective owners.

Follow us on social media to get the latest product and support information.

